

KAS®

Evinizin her yerindeyiz!

Vana - Kollektör - Flex - Armatür - PPRC

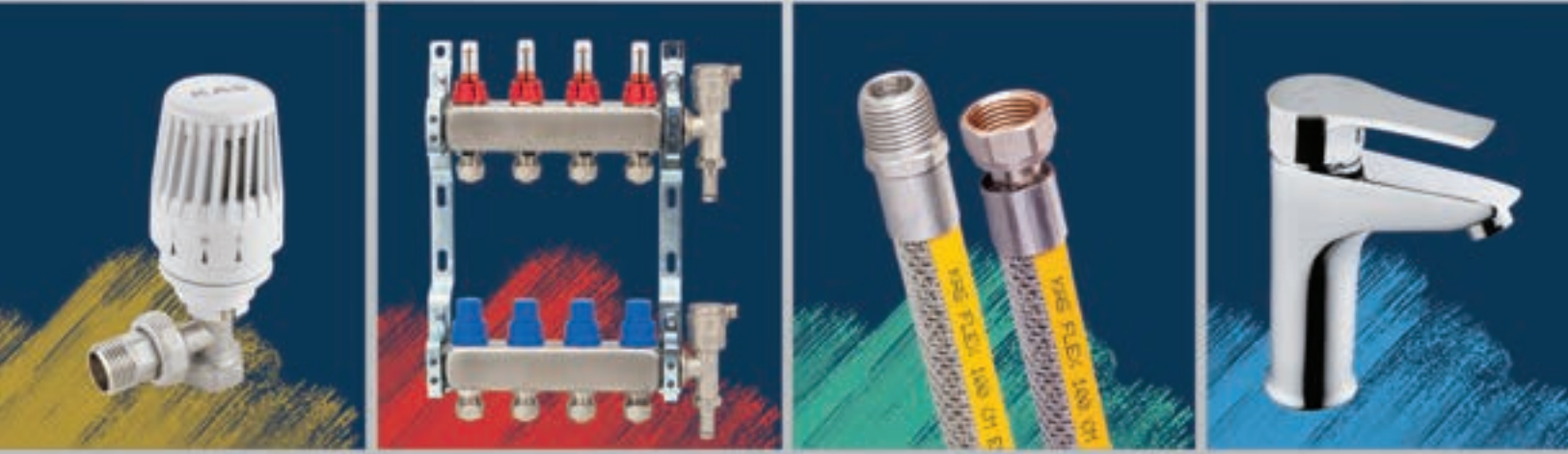

2023-01
Fiyat Listesi

www.kas.com.tr

Dünya'da 100'den fazla ülkede,
aynı statüye sahip firmalarla

"Uluslararası Güvenli Ticaret Ağı"

oluşturmamıza imkan sağlayacak,

Yetkilendirilmiş Yükümlü Sertifikamızı Aldık.

TÜRKİYE CUMHURİYETİ
TİCARET BAKANLIĞI



Yetkilendirilmiş Yükümlü Sertifikası
Kayalar Pres Döküm San. Tic. Ltd. Şti.

Bu belge, 4458 sayılı Gümrük Kanununun 5/A maddesine
istinaden yukarıda unvanı kayıtlı kişi adına,
yetkilendirilmiş yükümlü statüsünün sağladığı hak ve
kolaylıklardan yararlandırılmak üzere düzenlenmiştir.

Sertifika No: TR/AEOF/20340026



Ad Soyadı *Yakup Çakır*
Unvan *Ticaret, Gümrük ve Dış Ticaret
Bölge Müdürü*

KAS



**Sizlere sunduğumuz kaliteden
hiçbir zaman ödün vermeyiz.**



Kayalar Grup

Kayalar Grup, bir aile şirketi olarak üretim faaliyetlerine 1970 yılında İstanbul'da üç kardeş tarafından başlamış, 1984 yılında kurulan Kayalar Pres Ltd. Şti. adı altında, pirinçten mamül parça ve fittingsler ile üretime devam ederek 1994 yılında KAS markasını tescil ettirmiştir. Böylece radyatör vanası ve pirinç fittingsler başta olmak üzere, sıhhi tesisat ve ısıtma tesisatları için yapmış olduğu ürün üretimini KAS markası ile piyasaya sunmaya başlamıştır. 1999 yılında İstanbul Sancaktepe'de bulunan ve bu gün 12.000 m² kapalı alana sahip üretim tesisine yerleşerek ürün çeşidini ve üretim kapasitesini artırmıştır.

Pazarlama ve satış faaliyetlerinin ayrı bir organizasyon altında yapılabilmesi amacıyla da 2000 yılında KASPA DIŞ TİC. A.Ş. grubun bünyesinde faaliyetlerine başlamıştır. Kayalar Grup, büyüme stratejisi doğrultusunda paslanmaz flex hortum imalatına başlanmış ve bu amaçla 2004 yılında Kayalar Armatür A.Ş. şirketini kurmuştur. 2009 yılında plastik boru ve ek parçaları üretimi, 2010 yılında da musluk ve su armatürleri üretimini gruba dahil edilmiştir. Üretim faaliyetlerindeki 50. yılında Kayalar Grup, bünyesinde bulunan 4 şirketi, 3 farklı üretim tesisi, konusunda bilgili ve deneyimli üretim, satış ve pazarlama ekipleri ile sektörün en köklü kuruluşlarından birisi halini almıştır.

Alanında birçok yeniliğe öncülük eden Kayalar Grup 50. yılında 300'e yakın ürün grubunda 1000'i aşkın ürün çeşidi ile müşterilerine hizmet vermektedir. Sektöründe doğalgaz, içme suyu, yangın tesisatları ile inşaat sektöründe, konut ve sanayide yer alan sıvı ve gaz akışkan tesisatlarında kullanılan birçok teknik ürünü müşterilerine sunan Kayalar Grup, kaliteyi müşterisinin en temel hakkı olarak görmektedir. TSE, TS EN, CEN, TSEK, GHOST, CE, Kiwa, SEPRO, ISO 9001, ISO 27001 gibi Sistem ve ürün kalite belgeleri ile hem üretim ve yönetim sistemlerinin, hem de ürettiği ürünlerin kalitesini güvence altında tutmaktadır. Toplam kalite yönetimi, stratejik yönetim ve değişim yönetimi tekniklerini aktif olarak uygulayarak günün koşullarına uygun ürün ve hizmetler geliştirmektedir. Üretim teknolojileri alanında çağın ve sektörün gelişmelerini takip ederek en üst teknoloji ile üretim yapmak amacıyla üretim teknolojileri alanında ciddi yatırımlara imza atan Kayalar Grup, bunun bir neticesi olarak KAS markasını sektörün verimlilik liderliği, maliyet liderliği ve inovasyon liderliğinde ilk sıralarda yer alan bir marka haline getirmiştir. KAS Ar-Ge departmanının üretim teknikleri,



ürünlere getirdiđi inovatif yaklařımı ve sahip olunan birçok patentli buluş ile KAS ürünleri, sektörde kalitesi, güvenilirliđi, ergonomisi ve kullanım kolaylıđı ile rakiplerinden fark edilen ürünler olarak görölmektedir. Katılımcı yönetim anlayışı ile süreçlerini sürekli iyileřtiren, bilimsel yöntem ve sorun çözme teknikleri ile deđişim ve iyileřtirme süreçlerini yöneten, takım çalışmalarını ile etkin ve verimli bir üretim ortamını oluřturan Kayalar Grup, sektördeki liderliđini pekiřtirmektedir. Ürün ve hizmetlerini müşteri odaklı gerçekleřtirmeyi iş hayatının olmazsa olmaz unsurlarından gören Kayalar Grup, pazarlama ve müşteri hizmetleri konusunda da geliřtirdiđi yaklařımları ve müşteri anlayışı sayesinde sektörün en beđenilen kuruluřlarından birisi olmuřtur.

KASPA DIŐ TİC. A.Ő. bünyesindeki pazarlama grubu, gerek iletiřimin, gerek müşteri beklentileri konusundaki hassasiyetin, gerekse satış ve satış sonrası hizmet ve desteklerin geliřtirilmesi konusunda yeni yaklařımlar ve hizmetler üretmek üzere çalışan uzman ekibi ile sektörde müşterisine en hızlı ve en dođru hizmeti sunmayı amaçlamıř, yaptıđı eğitim ve bilgilendirme faaliyetleri ile sektörün büyümesine ve geliřmesine önemli destek sađlamıřtır. Sadece üretim hayatında deđil sosyal hizmet anlayışı ile de Kayalar Grup sektördeki benzeri kuruluřlardan ayrıcalıklı bir yapıya kavuřmuřtur. Özellikle genç nesillerin eğitimi ve dođru bilgilendirilmesi amacıyla mesleki eğitimleri veren kurum ve kuruluřlar ile yakın diyalog içerisinde bulunmakta ve desteklemektedir. Bu kapsamda KAS AKADEMİ'yi kurarak çok sayıda öğrenciye destek vermekte ve özellikle metal endüstrisinde eğitim veren teknik liseler başta olmak üzere eğitim kurumlarımıza desteklerini sürdürmektedir. Ülkemizin adını yurt dışında da başarı ile temsil eden Kayalar Grup, yurt içinde edindiđi tecrübe, kalite yaklařımı ve müşteri odaklı pazarlama süreçlerinin tüm birikimleri ile ihracat faaliyetlerinde kısa sürede büyük bir ivme yakalamıř ve komřu ülkeler başta olmak üzere onlarca ülkeye gerçekleřtirdiđi ihracatını ile adını ülkemiz sınırları dışına tařımıřtır. Gelecek vizyonunda KAS markasını bir dünya markası haline getirmek yatan Kayalar Grup bu bağlamda belirlediđi stratejik hedefleri dođrultusunda müşterilerinin de desteđi ile yeni ve inovatif ürünleri ve müşteri hizmetleri ile geleceđin büyüyen gücü olmaya devam etmektedir.

► İÇİNDEKİLER



► Su ve Doğalgaz
Tesisat Ürünleri

08

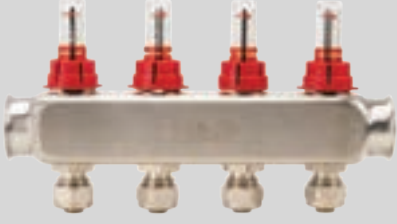

► Kas Therm
Isı Sistemleri

24



► Flex Grubu

34



► Kastak Grubu

42



► Armatür

48



► Duş Setleri

110



► PPRC Grubu

126

► Armatür ve Duş Setleri

Yasemin
Gold

50



Yasemin

52



Lilyum

54



Arnika

56



Gülbahar

58



Defne Colored

60



Defne

62



Hilal

64



Antoryum

68



Gülnehal

72



Çanak

76



Kardelen

78



Nilüfer

80



Zirkonyum

82



Medikal

86



Berilyum

88



Mutfak

92



Endüstriyel

96



Fotoselli

98



Ankastre

102



Musluk

103



Taharet
Musluğu

105



Yedek Parça

107



Duş Setleri

110



SU VE DOĐALGAZ TESİSAT ÜRÜNLERİ



Tüketici dostu çözümlerimizin en yenisi

Termostatik Radyatör Vanası

*Yaşam alanınızı istediğiniz ısı seviyesinde tutar,
ihtiyaç fazlası ısınma ve tüketimin önüne geçerek*

%30'a varan tasarruf sağlar



► SU VE DOĞALGAZ TESİSAT ÜRÜNLERİ



TS EN 331
► **Gaz Küresel Vana**
(Mob 5)

KOD	AÇIKLAMA	K. AD.	B. FİYATI
07.04.830	1/2"	100	53,90 TL
07.04.831	3/4"	80	83,30 TL
07.04.402	1"	40	148,00 TL
07.04.403	1 1/4"	20	272,00 TL
07.04.404	1 1/2"	12	436,00 TL
07.04.405	2"	8	649,00 TL



TS EN 331
► **Gaz Küresel Vana - Kilitli**
(Mob 5)

KOD	AÇIKLAMA	K. AD.	B. FİYATI
07.05.830	1/2"	100	57,00 TL
07.05.831	3/4"	80	88,50 TL
07.05.402	1"	40	157,00 TL
07.03.801	3/4"-1/2"	80	104,00 TL



TS EN 13828
► **Su Küresel Vana - İçme Suyu**
(PN 10)

KOD	AÇIKLAMA	K. AD.	B. FİYATI
08.01.430	1/2"	100	76,40 TL
08.01.431	3/4"	80	90,00 TL
08.01.432	1"	40	182,00 TL
08.01.433	1 1/4"	20	297,00 TL
08.01.434	1 1/2"	12	468,00 TL
08.01.435	2"	8	788,00 TL



TS EN 13547
► **Su Küresel Vana - Endüstriyel**
(PN 40)

KOD	AÇIKLAMA	K. AD.	B. FİYATI
08.02.430	1/2"	100	78,30 TL
08.02.431	3/4"	80	96,00 TL
08.02.432	1"	40	176,00 TL
08.02.433	1 1/4"	20	276,00 TL
08.02.434	1 1/2"	12	419,00 TL
08.02.435	2"	8	649,00 TL

► SU VE DOĞALGAZ TESİSAT ÜRÜNLERİ



► **Su Küresel Vana**
(PN 40)

KOD	AÇIKLAMA	K. AD.	B. FİYATI
08.09.530	1/2"	100	57,60 TL
08.09.531	3/4"	80	84,20 TL
08.09.452	1"	40	141,00 TL



► **Su Küresel Vana**
(PN 16)

KOD	AÇIKLAMA	K. AD.	B. FİYATI
80.61.426	2 1/2"	4	2.891,00 TL
80.61.427	3"	3	3.907,00 TL
80.61.428	4"	2	7.622,00 TL



► **Su Küresel Vana**
(PN 40)

KOD	AÇIKLAMA	K. AD.	B. FİYATI
08.09.528	1/4"	120	60,00 TL
08.09.529	3/8"	120	57,40 TL



► **TS EN 13547**
► **Su Küresel Vana - Endüstriyel**
(PN 25)

KOD	AÇIKLAMA	K. AD.	B. FİYATI
08.09.430	1/2"	100	77,60 TL
08.09.431	3/4"	80	93,90 TL
08.09.432	1"	40	172,00 TL
08.09.433	1 1/4"	20	263,00 TL
08.09.434	1 1/2"	12	419,00 TL
08.09.435	2"	8	649,00 TL

► SU VE DOĞALGAZ TESİSAT ÜRÜNLERİ



► **Su Küresel Vana - Kelebek Kollu (PN 25)**

KOD	AÇIKLAMA	K. AD.	B. FİYATI
08.03.430	1/2" Dış Dişli	100	79,00 TL
08.03.431	3/4" Dış Dişli	80	108,00 TL
08.03.432	1" Dış Dişli	40	172,00 TL
08.04.430	1/2" İç Dişli	100	78,30 TL
08.04.431	3/4" İç Dişli	80	100,00 TL
08.04.432	1" İç Dişli	40	172,00 TL

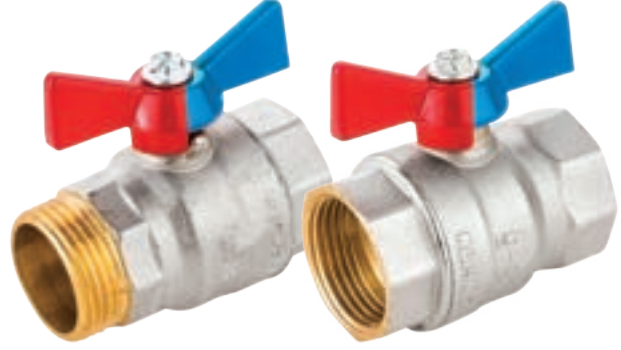

► **Su Küresel Vana - Kelebek Kollu (PN 40)**

KOD	AÇIKLAMA	K. AD.	B. FİYATI
08.03.530	1/2" Dış Dişli	100	62,00 TL
08.03.531	3/4" Dış Dişli	80	89,40 TL
08.03.532	1" Dış Dişli	40	156,00 TL
08.04.530	1/2" İç Dişli	100	62,70 TL
08.04.531	3/4" İç Dişli	80	92,10 TL
08.04.532	1" İç Dişli	40	155,00 TL



► **Rakorlu Su Küresel Vana Kelebek Kollu**

KOD	AÇIKLAMA	K. AD.	B. FİYATI
08.05.530	1/2"	60	104,00 TL
08.05.531	3/4"	50	154,00 TL
08.08.327	1"	40	191,00 TL
08.05.329	1 1/4"	20	338,00 TL



► **Rakorlu Su Küresel Vana Sensör Kovanlı**

KOD	AÇIKLAMA	K. AD.	B. FİYATI
08.07.452	1"	40	178,00 TL

► SU VE DOĞALGAZ TESİSAT ÜRÜNLERİ



► **Dişli - PPRC Bağlantılı Küresel Vana**

KOD	AÇIKLAMA	K. AD.	B. FİYATI
08.08.730	3/4" Dişli - DN20 PPRC Bağlantılı	50	158,00 TL
08.08.731	1" Dişli - DN25 PPRC Bağlantılı	40	209,00 TL
08.08.732	1 1/4" Dişli - DN32 PPRC Bağlantılı	30	287,00 TL



► **PPRC Bağlantılı Küresel Vana**

KOD	AÇIKLAMA	K. AD.	B. FİYATI
08.09.730	DN20 - DN20 PPRC Bağlantılı	50	129,00 TL
08.09.731	DN25 - DN25 PPRC Bağlantılı	40	182,00 TL
08.09.732	DN32 - DN32 PPRC Bağlantılı	30	254,00 TL



► **Mini Küresel Vana**

KOD	AÇIKLAMA	K. AD.	B. FİYATI
05.03.320	1/4"	250	47,20 TL
05.03.321	3/8"	250	44,08 TL
05.03.322	1/2"	200	49,91 TL
05.03.323	3/4"	120	73,10 TL
05.04.322	1/2" Boşaltma Vanası	200	93,40 TL



► **Filtreli Küresel Vana**

KOD	AÇIKLAMA	K. AD.	B. FİYATI
08.08.448	1/2"	60	148,00 TL
08.08.449	3/4"	50	203,00 TL

► SU VE DOĞALGAZ TESİSAT ÜRÜNLERİ



► Köşe Termostatik Radyatör Vanası (Jaklı)

KOD	AÇIKLAMA	K. AD.	B. FİYATI
13.50.001	1/2"	30	175,00 TL

* 15°C Sabitleme yapılabilir.



► Köşe Termostatik Radyatör Vanası (Jaklı)

KOD	AÇIKLAMA	K. AD.	B. FİYATI
13.50.002	1/2" - 16x2 Pex-B Bağlantılı	30	191,00 TL

* 15°C Sabitleme yapılabilir.



051



053



054



055

► Kompakt Ventil Termostatik Vana

yeni ürün

KOD	AÇIKLAMA	K. AD.	B. FİYATI
23.60.051	Kompakt Ventil	30	196,00 TL
23.60.053	Kompakt Ventil (Alüminyum Radyatör İçin)	30	278,00 TL
23.60.054	Kompakt Ventil	30	250,00 TL
23.60.055	Kompakt Ventil	30	255,00 TL

* 15°C Sabitleme yapılabilir. Termostatik kafa fiyata dahildir.



► Düz Termostatik Vana

KOD	AÇIKLAMA	K. AD.	B. FİYATI
13.40.009	1/2"	30	246,00 TL

* 15°C Sabitleme yapılabilir.

► SU VE DOĞALGAZ TESİSAT ÜRÜNLERİ



► Aksenal Termostatik Vana

KOD	AÇIKLAMA	K. AD.	B. FİYATI
13.40.007	1/2"	30	271,00 TL

* 15°C Sabitleme yapılabilir.

► Aksenal Termostatik Vana

KOD	AÇIKLAMA	K. AD.	B. FİYATI
13.40.008	1/2" Boru Bağlantılı	30	279,00 TL
13.40.006	1/2" Pex Bağlantılı	30	286,00 TL

* 15°C Sabitleme yapılabilir.



► Köşe Radyatör Vanası (Tip3)

KOD	AÇIKLAMA	K. AD.	B. FİYATI
04.07.307	1/2"	50	115,00 TL
04.07.309	1/2" - 16x2 Pex-B Bağlantılı	50	129,00 TL



► Köşe Radyatör Vanası (Tip3)

KOD	AÇIKLAMA	K. AD.	B. FİYATI
04.11.307	1/2"	50	138,00 TL
04.11.309	1/2" - 16x2 Pex-B Bağlantılı	50	153,00 TL

► SU VE DOĞALGAZ TESİSAT ÜRÜNLERİ



► Köşe Rakorlu Vana (Tip6)

KOD	AÇIKLAMA	K. AD.	B. FİYATI
04.14.307-01	1/2"	50	63,10 TL
04.14.309-01	1/2"- 16x2 Pex-B Bağlantılı	50	78,60 TL

(*) Yapı malzemelerinin tabi olacağı kriterler hakkında yönetmelik kapsamındaki yapılarda kullanılmaz.



► Köşe Radyatör Vanası (Tip4)

KOD	AÇIKLAMA	K. AD.	B. FİYATI
04.01.307	1/2"	50	77,10 TL
04.01.309	1/2"- 16x2 Pex-B Bağlantılı	50	88,20 TL



► Köşe Rakorlu Vana

KOD	AÇIKLAMA	K. AD.	B. FİYATI
04.14.307	1/2"	50	57,70 TL
04.14.309	1/2"- 16x2 Pex-B Bağlantılı	50	74,70 TL

(*) Yapı malzemelerinin tabi olacağı kriterler hakkında yönetmelik kapsamındaki yapılarda kullanılmaz.



► Köşe Radyatör Vanası (Tip3)

KOD	AÇIKLAMA	K. AD.	B. FİYATI
04.01.303	1/2"	50	88,10 TL
04.01.308	1/2"- 16x2 Pex-B Bağlantılı	50	100,00 TL
04.05.310	3/4"	50	117,00 TL

► SU VE DOĞALGAZ TESİSAT ÜRÜNLERİ



► **Köşe Radyatör Vanası (Tip3)**

KOD	AÇIKLAMA	K. AD.	B. FİYATI
04.01.304	1/2" - 16x2 Boru Bağlantılı	50	99,90 TL



► **Düz Radyatör Vanası (Tip3)**

KOD	AÇIKLAMA	K. AD.	B. FİYATI
04.02.301	1/2"	50	100,00 TL
04.04.301	1/2" - 16x2 Pex-B Bağlantılı	50	134,00 TL
04.05.311	3/4"	50	133,00 TL



► **Köşe Geri Dönüş Vanası (Tip3)**

KOD	AÇIKLAMA	K. AD.	B. FİYATI
04.04.309	1/2" - 16x2 Pex-B Bağlantılı	100	87,60 TL
04.04.305	1/2" G.D. Rakorlu Vana	50	66,40 TL

(*) Yapı malzemelerinin tabi olacağı kriterler hakkında yönetmelik kapsamındaki yapılarda kullanılmaz.



► **Düz - Köşe Rakor**

KOD	AÇIKLAMA	K. AD.	B. FİYATI
03.01.250	1/2" Düz	150	54,20 TL
03.01.251	3/4" Düz	90	78,00 TL
03.01.252	1" Düz	50	120,00 TL
03.02.260	1/2" Köşe	150	65,70 TL
03.02.261	3/4" Köşe	100	96,30 TL
03.02.262	1" Köşe	50	160,00 TL

► SU VE DOĞALGAZ TESİSAT ÜRÜNLERİ



► Filtreli Musluk (PN 10)

KOD	AÇIKLAMA	K. AD.	B. FİYATI
01.07.179	1/2" - 3/8" Taharat Musl.	160	53,50 TL
01.06.173	Çamaşır - Bulaşık Mak. Mus.	100	81,60 TL
01.05.173	Çamaşır - Bulaşık Mak. Mus. (Kumlu)	100	70,50 TL
01.07.179-01	1/2" - 3/8" Taharat Musl. (Aynalı)	160	57,70 TL
01.06.173-01	Çamaşır - Bulaşık Mak. Mus. (Aynalı)	100	84,90 TL
01.05.173-01	Çamaşır - Bulaşık Mak. Mus. (Kumlu) (Aynalı)	100	73,20 TL
01.03.171	Musluk Aynası	600	5,75 TL



► Bahçe Küresel (PN 10) Piriç Rakorlu

KOD	AÇIKLAMA	K. AD.	B. FİYATI
09.06.921	1/2" Tek Parça Rakorlu	50	101,00 TL
09.06.923	1/2" Tek Parça Rakorlu - Yeni	50	85,70 TL
09.03.922	3/4" Rakor 3/4" Bağlantı	50	122,00 TL



► Küresel Bas (PN 10)

KOD	AÇIKLAMA	K. AD.	B. FİYATI
10.01.370	3/4"	50	118,00 TL
10.01.371	3/4" Paslanmaz Kol*	50	147,00 TL
10.01.372	3/4" - 3/4" Bağlantılı	50	131,00 TL

(*) Kol ve somun nemli ortamlarda kullanıma uygun paslanmaz çelikten (AISI 304) imal edilmiştir.

Talep edildiği takdirde kelebek kolu olarak imal edilebilir.



► Bahçe Küresel (PN 10) Piriç Rakorlu Kelebek Kol

KOD	AÇIKLAMA	K. AD.	B. FİYATI
09.07.921	1/2" Tek Parça Rakorlu	50	101,00 TL
09.04.922	3/4" Rakor 3/4" Bağ.	50	122,00 TL

► SU VE DOĞALGAZ TESİSAT ÜRÜNLERİ



► Çalparalı (Yatay) Çekvalf

KOD	AÇIKLAMA	K. AD.	B. FİYATI
80.82.460	1/2"	100	83,50 TL
80.82.461	3/4"	75	105,00 TL
80.82.462	1"	50	156,00 TL
80.82.463	1 1/4"	50	242,00 TL
80.82.464	1 1/2"	40	328,00 TL
80.82.465	2"	15	422,00 TL
80.82.466	2 1/2"	10	799,00 TL
80.82.467	3"	6	1.022,00 TL



► Yaylı (Dik) Çekvalf - Sessiz

KOD	AÇIKLAMA	K. AD.	B. FİYATI
80.81.470	1/2"	100	67,00 TL
80.81.471	3/4"	75	98,40 TL
80.81.472	1"	50	135,00 TL
80.81.473	1 1/4"	50	219,00 TL
80.81.474	1 1/2"	40	309,00 TL
80.81.475	2"	24	408,00 TL
80.81.476	2 1/2"	12	1.106,00 TL
80.81.477	3"	6	1.449,00 TL



► Doğalgaz Macunu - Doğalgaz Filtresi

KOD	AÇIKLAMA	K. AD.	B. FİYATI
80.32.820	1/2" Gaz Filtresi	70	209,00 TL
70.03.800	Doğalgaz Tesisat Macunu	24	62,00 TL



► Flatör - Paslanmaz Memeli

KOD	AÇIKLAMA	K. AD.	B. FİYATI
80.71.540	1/2"	50	110,00 TL
80.71.541	3/4"	50	126,00 TL
80.71.542	1"	50	152,00 TL
80.71.543	1 1/4"	20	428,00 TL
80.71.544	1 1/2"	20	489,00 TL
80.71.545	2"	20	555,00 TL

► SU VE DOĞALGAZ TESİSAT ÜRÜNLERİ



► Filtre (Pislik Tutucu)

KOD	AÇIKLAMA	K. AD.	B. FİYATI
12.02.340	1/2" Tip 2	150	53,80 TL
12.02.341	3/4" Tip 2	80	75,50 TL
12.02.342	1" Tip 2	50	122,00 TL
12.01.340	1/2" Tip 1	150	71,10 TL
12.01.341	3/4" Tip 1	80	101,00 TL
12.01.342	1" Tip 1	50	147,00 TL
80.31.343	1 1/4" Tip 1	30	266,00 TL
80.31.344	1 1/2" Tip 1	20	318,00 TL
80.31.345	2" Tip 1	10	485,00 TL
80.31.346	2" 1/2" Tip 1	8	812,00 TL
80.31.347	3" Tip 1	6	1.162,00 TL
80.31.348	4" Tip 1	4	2.517,00 TL



► Uzatma (25 mm)

KOD	AÇIKLAMA	K. AD.	B. FİYATI
80.01.101	1/2" 1 cm	500	13,92 TL
80.01.102	1/2" 1,5 cm	400	17,38 TL
80.01.103	1/2" 2 cm	300	20,78 TL
80.01.104	1/2" 2,5 cm	250	23,63 TL
80.01.105	1/2" 3 cm	200	27,96 TL
80.01.106	1/2" 4 cm	175	38,89 TL
80.01.107	1/2" 5 cm	150	46,19 TL



► Uzatma Grubu

KOD	AÇIKLAMA	K. AD.	B. FİYATI
80.04.160	1/2" - 3/4" Bas Uzatma	250	30,64 TL
80.04.175	3/4" Düz Batarya Uzatması	100	30,87 TL
80.04.176	3/4" Delikli Batarya Uza.	100	52,70 TL
80.04.180	1/2" Bulaşık Makinası Uza.	100	40,23 TL
80.04.185	3/4" Çamaşır Musluk Çatalı	100	47,31 TL



► Şiber Vana

KOD	AÇIKLAMA	K. AD.	B. FİYATI
11.01.850	1/2"	60	107,00 TL
11.01.951	3/4"	50	96,10 TL
11.01.852	1"	30	193,00 TL

► SU VE DOĞALGAZ TESİSAT ÜRÜNLERİ



► Rakorlar

KOD	AÇIKLAMA	K. AD.	B. FİYATI
80.23.241	1/2"	500	16,59 TL
80.23.242	3/4"	300	24,77 TL
80.23.243	1"	150	40,98 TL
80.23.244	1 1/4"	100	60,10 TL
80.23.245	1 1/2"	75	82,30 TL
80.23.246	2"	40	149,00 TL
80.22.191	3/4" Su Saati Rakoru	100	45,58 TL



► Stop Vana

KOD	AÇIKLAMA	K. AD.	B. FİYATI
11.02.850	1/2"	60	105,00 TL
11.02.851	3/4"	50	109,00 TL
11.02.852	1"	30	235,00 TL



► Nipel - Kromlu

KOD	AÇIKLAMA	K. AD.	B. FİYATI
02.02.200	3/8"	500	9,99 TL
02.02.201	1/2"	250	18,31 TL
02.02.202	3/4"	200	32,86 TL
02.02.203	1"	100	50,00 TL



► Orantılı Nipel - Redüksiyon

KOD	AÇIKLAMA	K. AD.	B. FİYATI
02.03.210	3/8" - 1/2" Orantılı Nipel	300	21,24 TL
02.03.211	1/2" - 3/4" Orantılı Nipel	250	28,51 TL
02.03.212	3/4" - 1" Orantılı Nipel	100	44,47 TL
02.01.195	3/8" - 1/2" Redüksiyon	500	14,72 TL
02.01.196	1/2" - 3/4" Redüksiyon	300	20,31 TL

► SU VE DOĞALGAZ TESİSAT ÜRÜNLERİ



► Emniyet Ventili - Sabit Ayarlı

KOD	AÇIKLAMA	K. AD.	B. FİYATI
7106610-3	1/2" İç Diş (3 BAR)	20	113,00 TL
7106610-4	1/2" İç Diş (4 BAR)	20	113,00 TL
7106610-5	1/2" İç Diş (5 BAR)	20	115,00 TL
7106610-6	1/2" İç Diş (6 BAR)	20	115,00 TL
7106610-8	1/2" İç Diş (8 BAR)	20	119,00 TL
7106610-9	1/2" İç Diş (9 BAR)	20	125,00 TL
7106610-10	1/2" İç Diş (10 BAR)	20	125,00 TL
7110601-3	1/2" Dış Diş (3 BAR)	20	106,00 TL
7110601-4	1/2" Dış Diş (4 BAR)	20	106,00 TL
7110601-5	1/2" Dış Diş (5 BAR)	20	108,00 TL
7110601-6	1/2" Dış Diş (6 BAR)	20	108,00 TL
7110601-8	1/2" Dış Diş (8 BAR)	20	113,00 TL
7110601-9	1/2" Dış Diş (9 BAR)	20	119,00 TL
7110601-10	1/2" Dış Diş (10 BAR)	20	119,00 TL



Evinizin Her Yerindeyiz!

(Daha fazlası kas.com.tr'de)



KAS YERDEN ISITMA SİSTEMLERİ



Yıllara meydan okuyan yeni ürünümüz

Kompakt Karışım Devresi

AR-GE ekibimizin, kaliteden ödün vermeyen inovasyon anlayışı ile tasarladığı, yeni bir teknoloji ile ürettiğimiz ürünümüzle işinizi kolaylaştırmaya devam ediyoruz.

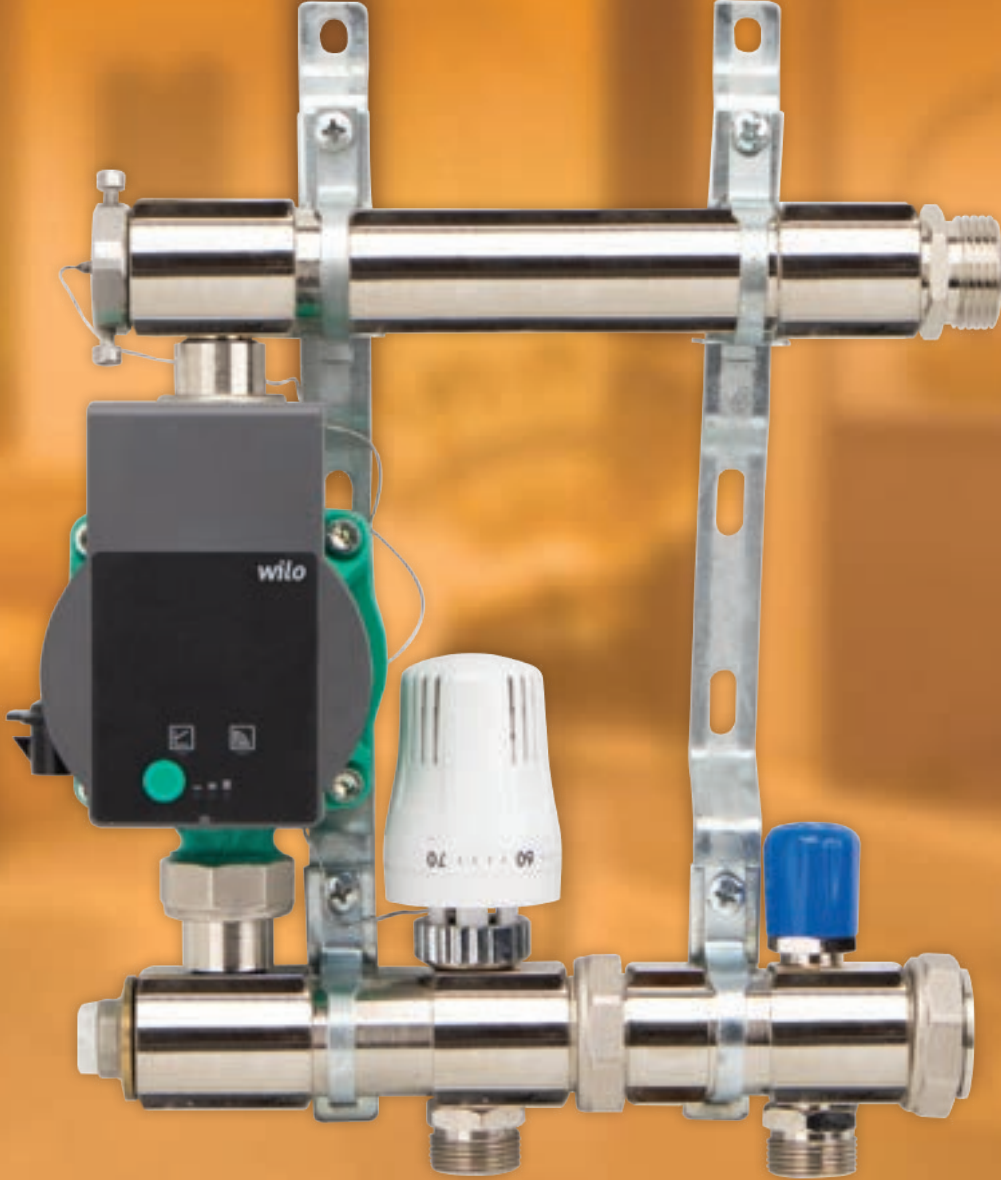

► KAS YERDEN ISITMA SİSTEMLERİ

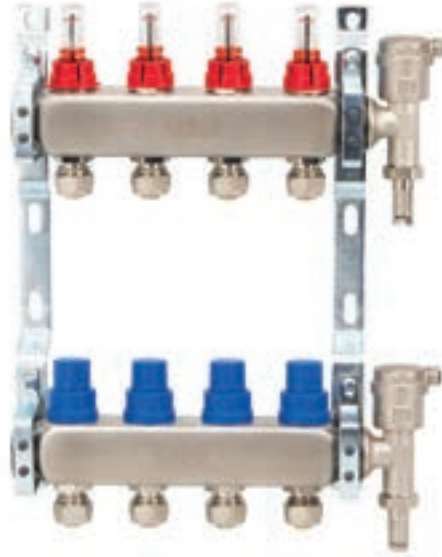

► Kare Tip Set - Debili - Termostat Set

KOD	AÇIKLAMA	K. AD.	B. FİYATI
18.22.902	2 Delikli	1	1.424,00 TL
18.22.903	3 Delikli	1	1.772,00 TL
18.22.904	4 Delikli	1	2.117,00 TL
18.22.905	5 Delikli	1	2.476,00 TL
18.22.906	6 Delikli	1	2.810,00 TL
18.22.907	7 Delikli	1	3.179,00 TL
18.22.908	8 Delikli	1	3.540,00 TL
18.22.909	9 Delikli	1	3.882,00 TL
18.22.910	10 Delikli	1	4.243,00 TL
18.22.911	11 Delikli	1	4.591,00 TL
18.22.912	12 Delikli	1	4.932,00 TL

Kutu İçeriği: 1 Adet Debili Kollektör, 1 Adet Termostatik Salmastralı Kollektör, 2 Adet Tahliye Vanası, 2 Adet Kelepçe

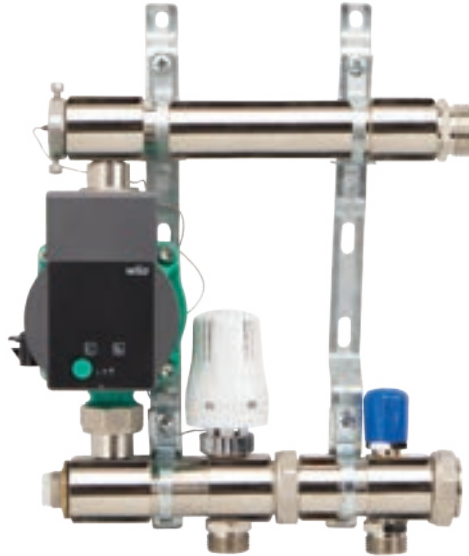

► Kompakt Karışım Devresi

KOD	AÇIKLAMA	K. AD.	B. FİYATI
20.01.001	-	1	3.187,00 TL

Kutu İçeriğine Sirkülasyon pompası dahil değildir.

► KAS YERDEN ISITMA SİSTEMLERİ

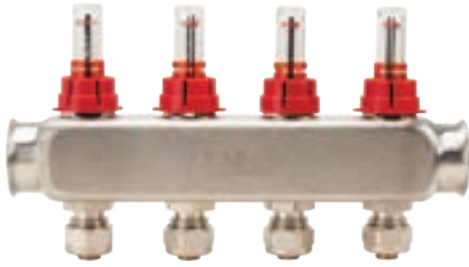

► Kare Tip Debili Kollektör

KOD	AÇIKLAMA	K. AD.	B. FİYATI
18.31.902	2 Delikli	8	501,00 TL
18.31.903	3 Delikli	8	692,00 TL
18.31.904	4 Delikli	4	891,00 TL
18.31.905	5 Delikli	4	1.076,00 TL
18.31.906	6 Delikli	4	1.264,00 TL
18.31.907	7 Delikli	4	1.458,00 TL
18.31.908	8 Delikli	4	1.644,00 TL
18.31.909	9 Delikli	4	1.829,00 TL
18.31.910	10 Delikli	4	2.023,00 TL
18.31.911	11 Delikli	4	2.225,00 TL
18.31.912	12 Delikli	2	2.397,00 TL

Not: 18.09.345 kodlu plastik purjörli kollektör tapası ayrıca satılır.



► Kare Tip Termostatik Kollektör

KOD	AÇIKLAMA	K. AD.	B. FİYATI
18.32.902	2 Delikli	8	470,00 TL
18.32.903	3 Delikli	8	679,00 TL
18.32.904	4 Delikli	4	874,00 TL
18.32.905	5 Delikli	4	1.055,00 TL
18.32.906	6 Delikli	4	1.240,00 TL
18.32.907	7 Delikli	4	1.430,00 TL
18.32.908	8 Delikli	4	1.612,00 TL
18.32.909	9 Delikli	4	1.794,00 TL
18.32.910	10 Delikli	4	1.979,00 TL
18.32.911	11 Delikli	4	2.175,00 TL
18.32.912	12 Delikli	3	2.350,00 TL

Not: 18.09.345 kodlu plastik purjörli kollektör tapası ayrıca satılır.



► Kollektör Rakoru - Termometre Saatli

KOD	AÇIKLAMA	K. AD.	B. FİYATI
20.06.005	1" Termometreli	30	185,00 TL
20.06.006	1" Manometreli	30	200,00 TL



► Rakorlu Su Küresel Vana Sensör Kovanlı

KOD	AÇIKLAMA	K. AD.	B. FİYATI
08.15.327	1" Termometreli	20	320,00 TL
08.16.327	1" Manometreli	20	331,00 TL

► KAS YERDEN ISITMA SİSTEMLERİ



► **Çift Taraflı Bağlantı Vanası**

KOD	AÇIKLAMA	K. AD.	B. FİYATI
20.06.001	1"	50	163,00 TL



► **Aktüatör**

KOD	AÇIKLAMA	K. AD.	B. FİYATI
20.07.203	230 V NC, 1 WATT	40	408,00 TL



► **2 Yollu Vana**

KOD	AÇIKLAMA	K. AD.	B. FİYATI
20.06.002	1"	20	277,00 TL



► **3 Yollu Vana**

KOD	AÇIKLAMA	K. AD.	B. FİYATI
20.06.003	1"	12	1.197,00 TL



► **Dijital - Analog Oda Termostatı**

KOD	AÇIKLAMA	K. AD.	B. FİYATI
20.07.303	Dijital - 230 V / +5°C +30°C Sıcaklık Aralığı	36	637,00 TL
20.07.304	Analog - 230 V / +5°C +30°C Sıcaklık Aralığı	36	519,00 TL

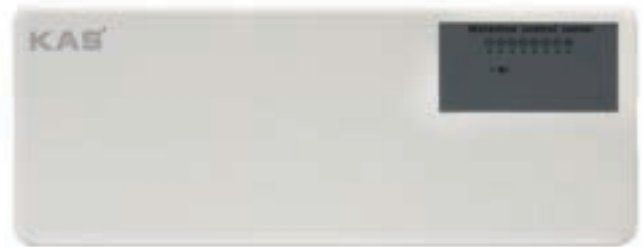

► **Dağıtıcı Terminal**

KOD	AÇIKLAMA	K. AD.	B. FİYATI
20.07.006	6 Zonlu Maks.	5	792,00 TL
20.07.008	8 Zonlu Maks.	5	818,00 TL
20.07.010	10 Zonlu Maks.	5	844,00 TL

► KAS YERDEN ISITMA SİSTEMLERİ



► *Kazan Emniyet Grubu*

KOD	AÇIKLAMA	K. AD.	B. FİYATI
80.60.710	1"	1	687,00 TL



► *Sirkülasyon Pompası*

KOD	AÇIKLAMA	K. AD.	B. FİYATI
20.07.101	-	1	5.569,00 TL



► *Boru Bağlantı Rakoru ve Sıkma Aparatı*

KOD	AÇIKLAMA	K. AD.	B. FİYATI
20.06.004	16x2	20	75,50 TL



► *Boru Fittings Sıkma Aparatı*

KOD	AÇIKLAMA	K. AD.	B. FİYATI
20.08.001	16-20-25-32 Çene	1	6.338,00 TL



► *Termostatik Salmastralı Kollektör 1" 16x2 (PN 10)*

KOD	AÇIKLAMA	K. AD.	B. FİYATI
18.16.502	2 Delikli	30	498,00 TL
18.16.503	3 Delikli	20	720,00 TL
18.16.504	4 Delikli	20	931,00 TL
18.16.505	5 Delikli	20	1.149,00 TL
18.16.506	6 Delikli	10	1.399,00 TL
18.16.507	7 Delikli	10	1.610,00 TL
18.16.508	8 Delikli	10	1.838,00 TL
18.16.509	9 Delikli	10	2.056,00 TL
18.16.510	10 Delikli	10	2.280,00 TL
18.16.511	11 Delikli	5	2.504,00 TL
18.16.512	12 Delikli	10	2.738,00 TL
18.16.513	13 Delikli	5	2.973,00 TL

** 17x2 Bağlantı İçin Fiyat Sorunuz



► *Debili Kontrollü Kollektör 1" 16x2 (PN 10)*

KOD	AÇIKLAMA	K. AD.	B. FİYATI
18.15.502	2 Delikli	20	509,00 TL
18.15.503	3 Delikli	10	751,00 TL
18.15.504	4 Delikli	10	978,00 TL
18.15.505	5 Delikli	10	1.207,00 TL
18.15.506	6 Delikli	5	1.431,00 TL
18.15.507	7 Delikli	5	1.658,00 TL
18.15.508	8 Delikli	5	1.893,00 TL
18.15.509	9 Delikli	5	2.101,00 TL
18.15.510	10 Delikli	5	2.350,00 TL
18.15.511	11 Delikli	5	2.580,00 TL
18.15.512	12 Delikli	5	2.821,00 TL
18.15.513	13 Delikli	5	3.063,00 TL

** 17x2 Bağlantı İçin Fiyat Sorunuz

► KAS YERDEN ISITMA SİSTEMLERİ

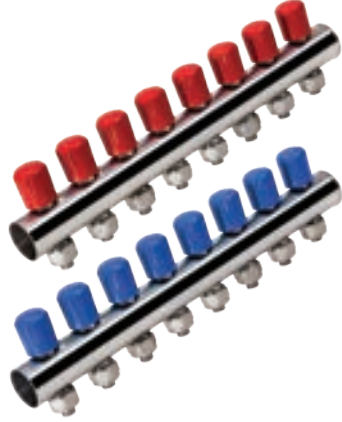

► Vanalı Kollektör - Paslanmaz Çelik 1"-16x2 (PN 10)

KOD	AÇIKLAMA	K. AD.	B. FİYATI
18.21.782	2 Delikli	30	205,00 TL
18.21.783	3 Delikli	20	276,00 TL
18.21.784	4 Delikli	20	346,00 TL
18.21.785	5 Delikli	20	417,00 TL
18.21.786	6 Delikli	10	488,00 TL
18.21.787	7 Delikli	10	558,00 TL
18.21.788	8 Delikli	10	628,00 TL
18.21.789	9 Delikli	10	698,00 TL
18.21.790	10 Delikli	10	769,00 TL
18.21.791	11 Delikli	10	834,00 TL
18.21.792	12 Delikli	10	899,00 TL
18.21.793	13 Delikli	10	963,00 TL

** 17x2 Bağlantı İçin Fiyat Sorunuz

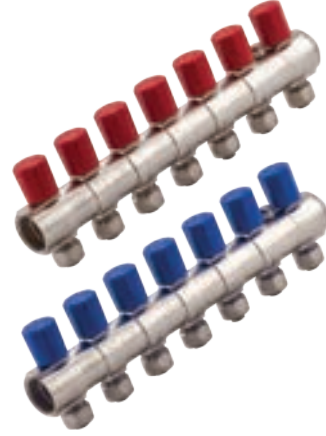

► Vanalı Kollektör - Pirinç 1"-16x2 (PN 10)

KOD	AÇIKLAMA	K. AD.	B. FİYATI
18.01.582	2 Delikli	30	236,00 TL
18.01.583	3 Delikli	20	333,00 TL
18.01.584	4 Delikli	20	430,00 TL
18.01.585	5 Delikli	20	527,00 TL
18.01.586	6 Delikli	10	623,00 TL
18.01.587	7 Delikli	10	717,00 TL
18.01.588	8 Delikli	10	816,00 TL
18.01.589	9 Delikli	10	918,00 TL
18.01.590	10 Delikli	10	997,00 TL
18.01.591	11 Delikli	10	1.127,00 TL
18.01.592	12 Delikli	10	1.241,00 TL
18.01.593	13 Delikli	10	1.335,00 TL

** 17x2 Bağlantı İçin Fiyat Sorunuz



► 3/8 Mini Vanalı Kollektör - Pirinç 1"-16x2 (PN 10)

KOD	AÇIKLAMA	K. AD.	B. FİYATI
18.19.882	2 Delikli	16	284,00 TL
18.19.883	3 Delikli	16	407,00 TL
18.19.884	4 Delikli	16	530,00 TL
18.19.885	5 Delikli	8	654,00 TL
18.19.886	6 Delikli	8	776,00 TL
18.19.887	7 Delikli	8	897,00 TL
18.19.888	8 Delikli	8	1.025,00 TL
18.19.889	9 Delikli	8	1.126,00 TL
18.19.890	10 Delikli	8	1.246,00 TL
18.19.891	11 Delikli	8	1.377,00 TL
18.19.892	12 Delikli	8	1.500,00 TL
18.19.893	13 Delikli	8	1.627,00 TL

** 17x2 Bağlantı İçin Fiyat Sorunuz

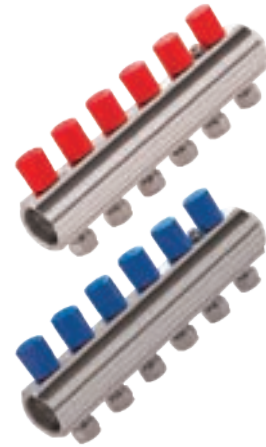

► Vanalı Kollektör - Pirinç 1 1/4"-16x2 (PN 10)

KOD	AÇIKLAMA	K. AD.	B. FİYATI
18.03.703	3 Delikli	16	556,00 TL
18.03.704	4 Delikli	16	717,00 TL
18.03.705	5 Delikli	16	880,00 TL
18.03.706	6 Delikli	8	1.051,00 TL
18.03.707	7 Delikli	8	1.201,00 TL
18.03.708	8 Delikli	8	1.363,00 TL
18.03.709	9 Delikli	8	1.521,00 TL
18.03.710	10 Delikli	8	1.698,00 TL
18.03.711	11 Delikli	8	1.874,00 TL
18.03.712	12 Delikli	8	2.035,00 TL
18.03.713	13 Delikli	8	2.196,00 TL

** 17x2 Bağlantı İçin Fiyat Sorunuz

► KAS YERDEN ISITMA SİSTEMLERİ



► Tahliye Musluğu - Purjör - Kollektör Tapası

KOD	AÇIKLAMA	K. AD.	B. FİYATI
18.09.345	1" Purjörlü Kollektör Tapası	450	33,29 TL
18.09.350	Manuel Purjörlü Tahliye Mus.	75	137,00 TL
18.09.351	Otomatik Purjörlü Tahliye Mus.	75	199,00 TL
80.57.507	1/2" Otomatik Purjör	76	96,90 TL
80.51.550	Test Nipel	1000	8,08 TL
80.51.570	Test Nipel (Çekvalfli)	1600	18,11 TL



► H-Ventil / By - Pass Bağlantı

KOD	AÇIKLAMA	K. AD.	B. FİYATI
14.01.878	16 x 2 Deliksiz	40	167,00 TL
06.05.881	H - Ventil	40	272,00 TL



► Yerden Isıtma Mini Küresel Vana

KOD	AÇIKLAMA	K. AD.	B. FİYATI
05.01.312	16 x 2 - 1/2" İç Dişli	180	68,50 TL
05.01.313	17 x 2 - 1/2" İç Dişli	150	107,00 TL
05.02.311	16 x 2 - 3/8" Dış Dişli	150	60,30 TL
05.02.312	16 x 2 - 1/2" Dış Dişli	150	82,70 TL
05.02.313	17 x 2 - 1/2" Dış Dişli	150	123,00 TL

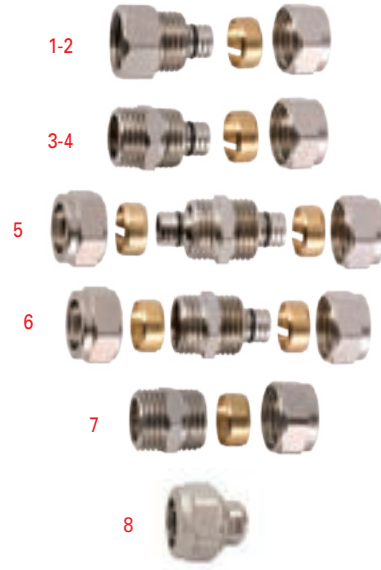

► Yerden Isıtma Bağlantı Rakorları

KOD	AÇIKLAMA	K. AD.	B. FİYATI
1	06.02.315 16 x 2 İç Dişli	250	36,10 TL
2	06.02.316 17 x 2 İç Dişli	250	50,70 TL
3	06.01.317 17 x 2 Dış Dişli	250	47,44 TL
4	06.01.318 16 x 2 Dış Dişli	250	31,00 TL
5	06.03.319 16 x 2 Hortum - Hortum	250	50,90 TL
6	06.03.320 16 x 2 Hortum - Boru	250	47,00 TL
7	06.01.314 16 x 2 Boru Bağ. Rakoru Dış Dişli	250	26,96 TL
8	06.04.480 16 x 2 Hortum Kör Tapa	250	23,76 TL

► KAS YERDEN ISITMA SİSTEMLERİ



► Kollektor Bağlantı Grubu

KOD	AÇIKLAMA	K. AD.	B. FİYATI
70.01.390	40cm Kollektör Dolabı	1	763,00 TL
70.01.391	60cm Kollektör Dolabı	1	939,00 TL
70.01.392	80cm Kollektör Dolabı	1	1.262,00 TL
70.01.491	60cm Kollektör Dolabı-KasTherm	1	1.249,00 TL
70.01.492	80cm Kollektör Dolabı-KasTherm	1	1.534,00 TL
70.01.493	100cm Kollektör Dolabı-KasTherm	1	1.835,00 TL
70.01.494	120cm Kollektör Dolabı-KasTherm	1	2.048,00 TL
18.20.502	1" Kollektör Kelepçesi	40	32,38 TL
18.20.503	1 1/4" Kollektör Kelepçesi	30	37,41 TL
18.20.504	1" Kollektör Kelepçesi	40	31,29 TL



► Pe-Rt Boru

KOD	AÇIKLAMA	K. AD.	B. FİYATI
80.20.016-400	16 x 2	400	9,88 TL
80.10.016-400	16x2 Oksijen Bariyerli	400	11,24 TL



► Şap Katkısı

KOD	AÇIKLAMA	K. AD.	B. FİYATI
20.08.002	-	10 L	1.270,00 TL

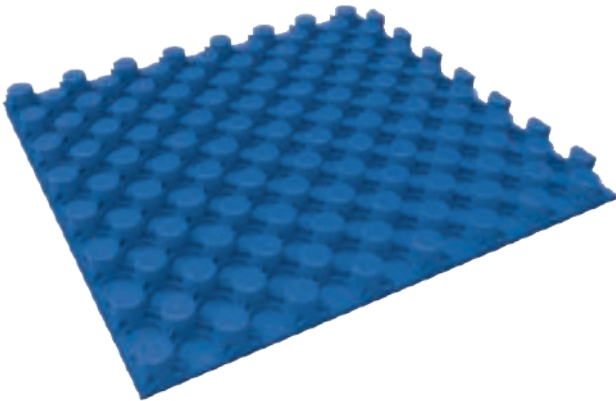

► Yerden Isıtma İzolasyon Paneli - Kenar İzolasyon Bandı

KOD	AÇIKLAMA	K. AD.	B. FİYATI
20.08.010	İzolasyon Paneli - Folyolu 72 x 72 cm - 0,51M ²	10	Fiyat Sorunuz
20.08.011	İzolasyon Paneli 60x120 cm - 0,72M ²	10	Fiyat Sorunuz
20.08.020	Kenar İzalasyon Bandı 25M	1	Fiyat Sorunuz



► KasTherm Sunum Çantası

KOD	AÇIKLAMA	K. AD.	B. FİYATI
20.09.001	Büyük Boy	1	4.797,00 TL
20.09.002	Küçük Boy	1	3.609,00 TL

► KAS YERDEN ISITMA SİSTEMLERİ



► Radyatör Bağlantı Borusu (Pirinç)

KOD	AÇIKLAMA	K. AD.	B. FİYATI
40.00.040	40 cm	100	71,00 TL
40.00.050	50 cm	100	83,90 TL
40.00.060	60 cm	100	96,70 TL
40.00.090	90 cm	100	157,00 TL



► Radyatör Bağlantı Borusu S'li - Rakorlu

KOD	AÇIKLAMA	K. AD.	B. FİYATI
40.04.040	1/2" - 16x2 Pex-B Bağlantı 40 cm	50	70,50 TL
40.04.050	1/2" - 16x2 Pex-B Bağlantı 50 cm	50	71,70 TL
40.04.060	1/2" - 16x2 Pex-B Bağlantı 60 cm	50	72,60 TL
40.04.090	1/2" - 16x2 Pex-B Bağlantı 90 cm	50	104,00 TL



► Radyatör Bağlantı Borusu Düz - Rakorlu

KOD	AÇIKLAMA	K. AD.	B. FİYATI
40.02.040	1/2" - 16x2 Pex-B Bağlantı 40 cm	70	69,00 TL
40.02.050	1/2" - 16x2 Pex-B Bağlantı 50 cm	70	70,80 TL
40.02.060	1/2" - 16x2 Pex-B Bağlantı 60 cm	50	72,00 TL
40.02.090	1/2" - 16x2 Pex-B Bağlantı 90 cm	50	98,50 TL



► Radyatör Bağlantı Borusu Dirsekli - Rakorlu

KOD	AÇIKLAMA	K. AD.	B. FİYATI
40.10.010	1/2"-16x2 Pex-B Bağlantı 10cm -85°	200	51,90 TL
40.11.010	1/2"-16x2 Pex-B Bağlantı 10cm -90°	200	51,90 TL
40.20.040	1/2"-16x2 Pex-B Bağlantı 40cm	50	71,20 TL
40.20.050	1/2"-16x2 Pex-B Bağlantı 50cm	50	73,20 TL
40.20.060	1/2"-16x2 Pex-B Bağlantı 60cm	50	73,90 TL
40.20.090	1/2"-16x2 Pex-B Bağlantı 90cm	50	101,00 TL

FLEX GRUBU

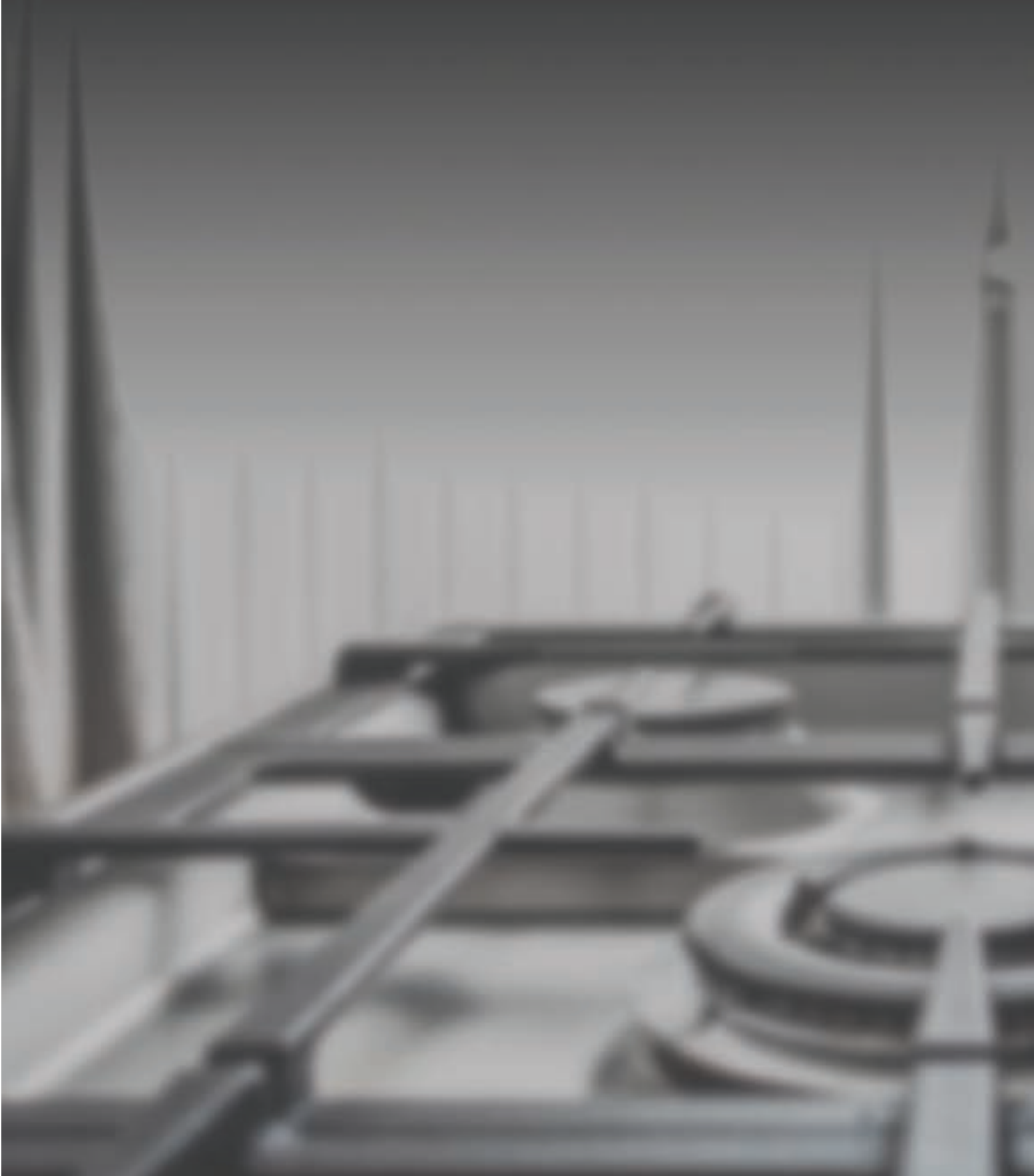

Paslanmaz elik tel rgs ve kaliteli dıř kaplamasıyla

Gaz Tesisatınızın en gvenilir halkası...

TS EN 14800 Avrupa standartlarına gre retilen, ocak, fırın, kombi vb. gaz yakan cihazlarda kullanılan, eğilebilir ve bklebilir yapıya sahip, **gvenilir, abuk ve kolay bağlantı** saėlayan Gaz Bağlantı Flexleri ile zamandan tasarruf saėlayın.



► FLEX GRUPLARI



TS 14800

► Örgülü Ocak Doğalgaz Bağlantı Flexleri (316 L)



KOD	N	S	DN	U	K. AD.	B. FİYATI
54.09.050	1/2"	1/2"	DN12	50 cm	25	122,00 TL
54.09.075	1/2"	1/2"	DN12	75 cm	25	143,00 TL
54.09.100	1/2"	1/2"	DN12	100 cm	25	154,00 TL
54.09.125	1/2"	1/2"	DN12	125 cm	25	170,00 TL
54.09.150	1/2"	1/2"	DN12	150 cm	20	209,00 TL

TS 13890

► Kombi Doğalgaz Bağlantı Flexleri - Makaronlu

KOD	N	S	DN	U	K. AD.	B. FİYATI
42.80.040	3/4"	3/4"	DN16	40 cm	50	87,80 TL
42.80.050	3/4"	3/4"	DN16	50 cm	50	94,90 TL
42.80.060	3/4"	3/4"	DN16	60 cm	30	103,00 TL
42.80.090	3/4"	3/4"	DN16	90 cm	30	119,00 TL
42.80.120	3/4"	3/4"	DN16	120 cm	30	136,00 TL



TS 13890

► Kompansatör Bağlantı - Makaronlu

KOD	B	B	DN	U	K. AD.	B. FİYATI
Kaynaklı						
48.02.060	1"	1"	DN25	60 cm	25	374,00 TL
48.12.065	1 1/4"	1 1/4"	DN32	65 cm	20	568,00 TL
48.22.075	1 1/2"	1 1/2"	DN40	75 cm	10	1.028,00 TL
48.32.085	2"	2"	DN50	85 cm	8	1.576,00 TL
Dişli						
47.57.060	1"	1"	DN25	60 cm	25	278,00 TL
47.59.065	1 1/4"	1 1/4"	DN32	65 cm	20	604,00 TL
47.61.075	1 1/2"	1 1/2"	DN40	75 cm	10	878,00 TL
47.63.085	2"	2"	DN50	85 cm	8	1.349,00 TL

TS 13890

► Sayaç Bağlantı Flexi - Makaronlu Paslanmaz

KOD	N	S	DN	U	K. AD.	B. FİYATI
50.80.020	1"	1 1/4"	DN25	20 cm	30	178,00 TL
50.80.023	1"	1 1/4"	DN25	23 cm	30	178,00 TL
50.80.025	1"	1 1/4"	DN25	25 cm	25	181,00 TL
50.80.032	1"	1 1/4"	DN25	32 cm	50	188,00 TL
49.41.035	1 1/2"	2"	DN40	35 cm	10	832,00 TL
49.51.035	2"	2 1/2"	DN50	35 cm	8	1.126,00 TL

* N: Nipel M: Manşon S: Somun B: Boru U: Uzunluk

► FLEX GRUPLARI



TS 13890

► *Sayaç Bağlantı Flex Seti - Makaronlu Paslanmaz*

KOD	AÇIKLAMA	K. AD.	B. FİYATI
50.92.020-2	1" 20 cm Ön Bağ. DN25 - 13890	20	228,00 TL
50.90.025-2	1" 25 cm Ön Bağ. DN25 - 13890	20	243,00 TL
50.90.032-2	1" 32 cm Ön Bağ. DN25 - 13890	20	246,00 TL
50.91.020-2	1" 20 cm Yan Bağ. DN25 - 13890	20	228,00 TL
50.93.020	1" 20 cm Ön Bağ. DN25 - 13890	20	273,00 TL
50.93.023	1" 23 cm Ön Bağ. DN25 - 13890	20	271,00 TL



► *Sayaç Bağlantı Elemanları*

KOD	AÇIKLAMA	K. AD.	B. FİYATI
46.02.440	7.5 cm Konsol Sacı - Ön Bağlantı	50	19,37 TL
46.02.450	8.5 cm Konsol Sacı - Ön Bağlantı	50	17,15 TL
46.02.452	9.5 cm Konsol Sacı - Ön Bağlantı	50	28,79 TL
46.02.453	10.5 cm Konsol Sacı - Ön Bağlantı	50	20,99 TL
46.02.451	Konsol Sacı - Yan Bağlantı	50	22,48 TL
46.20.460-2	1" Sayaç Rakoru (Döküm)	50	52,80 TL
46.20.461	1" Sayaç Rakoru (Kromlu Döküm)	50	67,00 TL
46.20.463	1" Sayaç Rakoru (Purjörlü)	50	135,00 TL
46.20.470	G 10 - 16 Sayaç Rakoru (Çelik)	50	253,00 TL
46.20.480	G 25 Sayaç Rakoru (Çelik)	25	354,00 TL

► FLEX GRUPLARI



TS 13890

► Kaskad Gaz Bağlantı Flexi Paslanmaz

KOD	N	S	DN	U	K. AD.	B. FİYATI
50.70.020	1"	1"	DN25	20 cm	30	185,00 TL
50.70.030	1"	1"	DN25	30 cm	20	193,00 TL
50.70.040	1"	1"	DN25	40 cm	30	211,00 TL
50.70.050	1"	1"	DN25	50 cm	25	223,00 TL
50.70.060	1"	1"	DN25	60 cm	25	239,00 TL



TS 13890

► Brülör Bağlantı Flexleri - Makaronlu Paslanmaz

KOD	N	N	DN	U	K. AD.	B. FİYATI
49.03.017	1"	1"	DN25	17 cm	20	101,00 TL
49.12.019	1 1/4"	1 1/4"	DN32	19 cm	15	434,00 TL
49.22.021	1 1/2"	1 1/2"	DN40	21 cm	10	646,00 TL
49.32.021	2"	2"	DN50	21 cm	8	913,00 TL



► Fancoil Flexleri - Çıplak

KOD	N	S	DN	U	K. AD.	B. FİYATI
43.17.020	1/2"	1/2"	DN12	20 cm	50	47,88 TL
43.17.030	1/2"	1/2"	DN12	30 cm	50	51,20 TL
43.17.040	1/2"	1/2"	DN12	40 cm	50	54,40 TL
43.17.050	1/2"	1/2"	DN12	50 cm	50	57,70 TL
43.17.060	1/2"	1/2"	DN12	60 cm	50	60,90 TL
43.19.020	3/4"	3/4"	DN16	20 cm	50	73,20 TL
43.19.030	3/4"	3/4"	DN16	30 cm	50	77,90 TL
43.19.040	3/4"	3/4"	DN16	40 cm	50	82,70 TL
43.19.050	3/4"	3/4"	DN16	50 cm	50	87,10 TL
43.19.060	3/4"	3/4"	DN16	60 cm	30	91,90 TL
43.21.020	1/2"	3/4"	DN12	20 cm	50	80,30 TL
43.21.030	1/2"	3/4"	DN12	30 cm	50	82,10 TL
43.21.040	1/2"	3/4"	DN12	40 cm	50	86,30 TL
43.21.050	1/2"	3/4"	DN12	50 cm	50	89,60 TL
43.21.060	1/2"	3/4"	DN12	60 cm	30	89,94 TL
43.23.020	3/4"	1"	DN16	20 cm	30	120,00 TL
43.23.030	3/4"	1"	DN16	30 cm	30	125,00 TL
43.23.040	3/4"	1"	DN16	40 cm	30	130,00 TL
43.23.050	3/4"	1"	DN16	50 cm	30	134,00 TL
43.23.060	3/4"	1"	DN16	60 cm	25	136,00 TL



► Fancoil Flexleri - İzoleli

KOD	N	S	DN	U	K. AD.	B. FİYATI
43.18.020	1/2"	1/2"	DN12	20 cm	25	51,10 TL
43.18.030	1/2"	1/2"	DN12	30 cm	25	55,60 TL
43.18.040	1/2"	1/2"	DN12	40 cm	25	60,40 TL
43.18.050	1/2"	1/2"	DN12	50 cm	25	65,10 TL
43.18.060	1/2"	1/2"	DN12	60 cm	25	69,80 TL
43.20.020	3/4"	3/4"	DN16	20 cm	20	76,40 TL
43.20.030	3/4"	3/4"	DN16	30 cm	20	82,50 TL
43.20.040	3/4"	3/4"	DN16	40 cm	20	88,60 TL
43.20.050	3/4"	3/4"	DN16	50 cm	20	94,70 TL
43.20.060	3/4"	3/4"	DN16	60 cm	20	101,00 TL
43.22.020	1/2"	3/4"	DN12	20 cm	25	83,80 TL
43.22.030	1/2"	3/4"	DN12	30 cm	25	87,20 TL
43.22.040	1/2"	3/4"	DN12	40 cm	25	91,90 TL
43.22.050	1/2"	3/4"	DN12	50 cm	25	96,50 TL
43.22.060	1/2"	3/4"	DN12	60 cm	25	101,70 TL
43.24.020	3/4"	1"	DN16	20 cm	25	123,00 TL
43.24.030	3/4"	1"	DN16	30 cm	25	128,00 TL
43.24.040	3/4"	1"	DN16	40 cm	25	135,00 TL
43.24.050	3/4"	1"	DN16	50 cm	25	142,00 TL
43.24.060	3/4"	1"	DN16	60 cm	25	147,00 TL

* N: Nipel M: Manşon S: Somun B: Boru U: Uzunluk



► FLEX GRUPLARI



TS 10380

► Sprink Fleksi ve Bağlantı Seti

KOD	M	N	DN	U	K. AD.	B. FİYATI
57.20.050	1/2"	1"	DN20	50 cm	8	219,00 TL
57.20.070	1/2"	1"	DN20	70 cm	8	234,00 TL
57.20.100	1/2"	1"	DN20	100 cm	8	256,00 TL



► Su Bağlantı Flexleri

KOD	N	S	DN	U	K. AD.	B. FİYATI
44.20.010	1/2"	1/2"	DN12	10 cm	100	50,40 TL
44.20.020	1/2"	1/2"	DN12	20 cm	100	51,50 TL
44.20.030	1/2"	1/2"	DN12	30 cm	75	54,90 TL
44.20.040	1/2"	1/2"	DN12	40 cm	75	58,60 TL
44.20.050	1/2"	1/2"	DN12	50 cm	50	59,20 TL
44.20.060	1/2"	1/2"	DN12	60 cm	50	62,40 TL
44.20.090	1/2"	1/2"	DN12	90 cm	50	64,99 TL



► Su Bağlantı Flexleri

KOD	N	S	DN	U	K. AD.	B. FİYATI
44.22.010	1/2"	3/4"	DN12	10 cm	100	76,10 TL
44.22.020	1/2"	3/4"	DN12	20 cm	50	86,14 TL
44.22.030	1/2"	3/4"	DN12	30 cm	50	89,48 TL
44.22.040	1/2"	3/4"	DN12	40 cm	50	92,37 TL
44.22.050	1/2"	3/4"	DN12	50 cm	50	94,59 TL
44.22.060	1/2"	3/4"	DN12	60 cm	50	96,32 TL

45.23.010	3/4"	3/4"	DN16	10 cm	60	63,90 TL
45.23.020	3/4"	3/4"	DN16	20 cm	60	70,10 TL
45.23.030	3/4"	3/4"	DN16	30 cm	50	73,30 TL
45.23.040	3/4"	3/4"	DN16	40 cm	50	77,40 TL
45.23.050	3/4"	3/4"	DN16	50 cm	50	81,20 TL
45.23.060	3/4"	3/4"	DN16	60 cm	30	84,70 TL

* N: Nipel M: Manşon S: Somun B: Boru U: Uzunluk



► FLEX GRUPLARI KUTU (REGÜLATÖR) BAĞLANTI FLEXLERİ

► Nipel + Nipel Serisi

KOD	AÇIKLAMA	K. AD.	B. FİYATI
47.10.021	1/4" 20 cm (Mak. Paslanmaz N.)	25	219,00 TL
47.12.030-2	1/4" 30 cm (Mak. Paslanmaz N.)	20	172,00 TL

KOD	AÇIKLAMA	K. AD.	B. FİYATI
47.15.020-2	1 1/4" 11/11 Diş 20 cm Mak. Paslanmaz	25	344,00 TL

KOD	AÇIKLAMA	K. AD.	B. FİYATI
47.23.030	1 1/4" 14/11 Diş 30 cm Mak. Paslanmaz	25	440,00 TL

KOD	AÇIKLAMA	K. AD.	B. FİYATI
47.25.034	2" 11/11 Diş 34 cm Mak. Paslanmaz	8	1.021,00 TL

KOD	AÇIKLAMA	K. AD.	B. FİYATI
47.64.017-2	1/4" 11/11 Diş 16,5 cm Mak. Paslanmaz	25	145,00 TL
47.65.025-2	1/4" 11/11 Diş 25 cm Mak. Paslanmaz	25	251,00 TL

KOD	AÇIKLAMA	K. AD.	B. FİYATI
47.67.025-2	1 1/4" 11/11 Diş 25 cm Mak. Paslanmaz	25	156,00 TL

► Kısa Nipel + Boru Serisi

KOD	AÇIKLAMA	K. AD.	B. FİYATI
47.43.020	1 1/4" 14 Diş 20 cm Mak. Paslanmaz	25	535,00 TL

KOD	AÇIKLAMA	K. AD.	B. FİYATI
47.45.020-2	1 1/4" 11 Diş 20 cm Mak. Paslanmaz	25	452,00 TL

► Nipel + Rakor Serisi

KOD	AÇIKLAMA	K. AD.	B. FİYATI
47.41.020	1 1/4" 11 Diş 20 cm Mak. Paslanmaz	25	506,00 TL

► Nipel + Boru Serisi

KOD	AÇIKLAMA	K. AD.	B. FİYATI
47.37.020	1 1/4" 11 Diş 20 cm Mak. Paslanmaz	25	506,00 TL



► FLEX GRUPLARI

KUTU (REGÜLATÖR) BAĞLANTI FLEXLERİ

► Kısa Nipel + Nipel Serisi

KOD	AÇIKLAMA	K. AD.	B. FİYATI
47.49.017-2	1 1/4" 11/14 Diş 16,5 cm Mak. Paslanmaz	25	231,00 TL
47.49.020-2	1 1/4" 11/14 Diş 20 cm Mak. Paslanmaz	25	235,00 TL

KOD	AÇIKLAMA	K. AD.	B. FİYATI
47.39.025-2	1 1/4" 11 Diş 25 cm Mak. Paslanmaz	20	363,00 TL

► Rakor + Boru Serisi

KOD	AÇIKLAMA	K. AD.	B. FİYATI
47.35.020	1 1/4" 11 Diş 20 cm Mak. Paslanmaz	20	515,00 TL

KOD	AÇIKLAMA	K. AD.	B. FİYATI
47.51.027-2	1 1/4" 11/11 Diş 27 cm Mak. Paslanmaz	20	338,00 TL
47.70.027-2	1 1/4" 11/11 Diş 27 cm Mak. Paslanmaz	20	337,00 TL

► Nipel + Manşon Serisi

KOD	AÇIKLAMA	K. AD.	B. FİYATI
47.21.020-2	1 1/4" 11/11 Diş 20 cm (Mak. Paslanmaz)	25	323,00 TL

KOD	AÇIKLAMA	K. AD.	B. FİYATI
47.27.020	1 1/4" 14/11 Diş 20 cm Mak. Paslanmaz	25	467,00 TL

KOD	AÇIKLAMA	K. AD.	B. FİYATI
47.29.020	2" 11/11 Diş 20 cm Mak. Paslanmaz	8	1.145,00 TL

KOD	AÇIKLAMA	K. AD.	B. FİYATI
47.31.030	2" 11/11 Diş 34 cm Mak. Paslanmaz	8	1.173,00 TL

KOD	AÇIKLAMA	K. AD.	B. FİYATI
47.68.022-2	1 1/4" 11/11 Diş 21,5 cm Mak. Paslanmaz	25	335,00 TL
47.69.022	1 1/2" 11/11 Diş 21,5 cm Mak. Paslanmaz	15	700,00 TL
47.04.030	2" 30 cm Kutu Flex Mak. Paslanmaz	8	1.177,00 TL
47.06.030	2" 30 cm Kutu Flex N-N (Mak.)	8	991,00 TL

► Kör Tapa

KOD	AÇIKLAMA	K. AD.	B. FİYATI
46.08.007	1 1/4" 14 İnce Diş	100	55,40 TL
46.08.008	1 1/4" 11 Kalın Diş	100	55,40 TL





KASTAK GRUBU



Köşeyi döndüren tesisat

Dirsek yok, kaynak yok, avantajı çok!

- Tesisat bölgelerinde kirliliği ve zararı **en aza indirir.**
- Kaynak, pafta, kesme taşı, keten ve macun **gerektirmez.**
- Esnekliği sayesinde dirsek kullanımına **ihtiyaç yoktur.**
- Paslanmaz çelik hortumu ve dış kılıfı ile aşınmaya, paslanmaya **dayanıkladır.**
- Kanalların içerisine yerleştirilmesi sayesinde **estetik bir görüntü sağlar.**
- Depreme ve yangına daha dayanıklıdır. Japonya ve A.B.D'de 25 yılı aşkın süredir **güvenle kullanılmaktadır.**



Kastak Esnek Tesisat Sistemi



KASTAK®

yeni nesil doğalgaz tesisatı



7



2



6



4



5

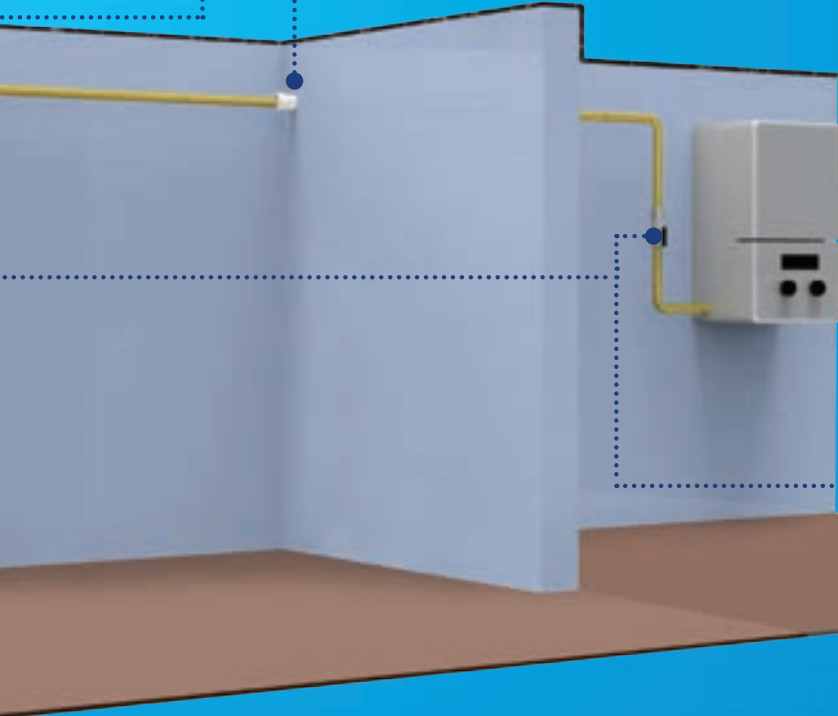

11



12

- 1 L Köşe
- 2 Dış Köşe
- 3 İç Köşe
- 4 Duvar Geçiş Kapağı (Kapalı)
- 5 Duvar Geçiş Kapağı (Açık)
- 6 TE Bağlantı Rakorları
- 7 Hortum Kanalı 3 mt
- 8 Kanal Geçiş Kapağı

- 9 Sayaç Kapama
- 10 Sayaç Bağlantı Rakorları
- 11 Hortum Bağlantı Rakorları
- 12 Rakorlu Doğalgaz Vanası
- 13 Kelepçe
- 14 Açılı Dış Köşe

► KASTAK GRUBU



► KAS-TAK Daire İçi Tesisat Hortumları

KOD	AÇIKLAMA	K. AD.	B. FİYATI
62.30.016	DN 16 - 45 mt	1	4.618,00 TL
62.30.020	DN 20 - 30 mt	1	3.070,00 TL
62.30.025	DN 25 - 25 mt	1	3.518,00 TL
62.30.050	DN 25 - 50 mt	1	7.215,00 TL
62.33.050	DN 32 - 50 mt	1	9.801,00 TL



► Hortum Bağlantı Rakorları

KOD	AÇIKLAMA	K. AD.	B. FİYATI
60.16.012	DN 16 x 1/2"	30	139,00 TL
60.16.016	DN 16 x 3/4"	24	140,00 TL
60.20.012	DN 20 x 1/2"	40	135,00 TL
60.20.016	DN 20 x 3/4"	40	139,00 TL
60.25.012-2	DN 25 x 1/2"	24	165,00 TL
60.25.016-2	DN 25 x 3/4"	32	175,00 TL
60.25.025-2	DN 25 x 1"	24	170,00 TL
60.32.025	DN 32 x 1"	40	463,00 TL
60.32.032	DN 32 x 1 1/4"	32	477,00 TL



► Flex Kesme Aparatı

KOD	AÇIKLAMA	K. AD.	B. FİYATI
49.51.001	-	1	Fiyat Sorunuz



► T Sıkma Aparatı

KOD	AÇIKLAMA	K. AD.	B. FİYATI
63.01.009	-	1	Fiyat Sorunuz



yeni ürün

► Rakorlu Doğalgaz Vanası

KOD	AÇIKLAMA	K. AD.	B. FİYATI
66.01.015-2	DN 25 - 1/2"	20	180,00 TL
66.01.020-2	DN 25 - 3/4"	20	202,00 TL



► TE Bağlantı Rakorları

KOD	AÇIKLAMA	K. AD.	B. FİYATI
61.20.020-2	DN 25 x DN 20 x DN 20	20	336,00 TL
61.20.021-2	DN 20 x DN 25 x DN 20	10	363,00 TL
61.20.025-2	DN 25 x DN 20 x DN 25	20	371,00 TL
61.25.020-2	DN 25 x DN 25 x DN 20	20	390,00 TL
61.25.025-2	DN 25 x DN 25 x DN 25	20	404,00 TL
61.32.2525-2	DN 32 x DN 25 x DN 25	12	761,00 TL
61.32.2532-2	DN 32 x DN 25 x DN 32	12	1.000,00 TL
61.32.3225-2	DN 32 x DN 32 x DN 25	10	973,00 TL
61.32.3232	DN 32 x DN 32 x DN 32	10	1.196,00 TL



► Flex Çözücü

KOD	AÇIKLAMA	K. AD.	B. FİYATI
60.00.050	-	1	Fiyat Sorunuz

► KASTAK GRUBU

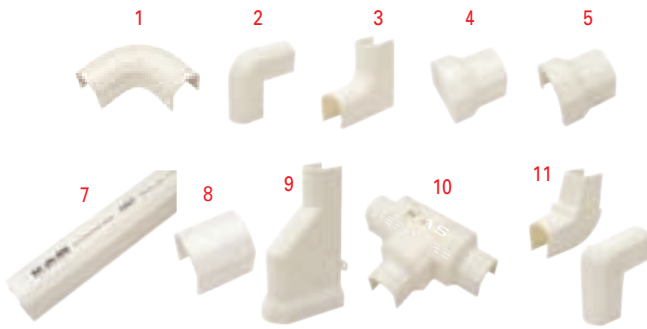

► Hortum Kanalları ve Ek Parçaları - DN 25

KOD	AÇIKLAMA	K. AD.	B. FİYATI
KREM			
1	63.21.003	L Köşe	50 17,42 TL
2	63.21.004	Dış Köşe	50 16,55 TL
3	63.21.005	İç Köşe	50 16,80 TL
4	63.21.006	Duvar Geçiş Kapağı (Kapalı)	50 11,28 TL
5	63.21.007	Duvar Geçiş Kapağı (Açık)	50 12,37 TL
7	63.33.002	Hortum Kanalı 2 mt	25 131,00 TL
8	63.21.010	Kanal Geçiş Kapağı	1 10,50 TL
9	63.21.015	Sayaç Kapama	9 25,45 TL
10	63.21.016	TE Kapama	20 21,50 TL
11	63.21.017	Açılı Dış Köşe	50 22,35 TL
	63.21.018	Açılı İç Köşe	50 22,70 TL

BEYAZ

1	63.22.003	L Köşe	50 17,42 TL
2	63.22.004	Dış Köşe	50 16,55 TL
3	63.22.005	İç Köşe	50 16,80 TL
4	63.22.006	Duvar Geçiş Kapağı (Kapalı)	50 11,28 TL
5	63.22.007	Duvar Geçiş Kapağı (Açık)	50 12,37 TL
7	63.34.002	Hortum Kanalı 2 mt	25 131,00 TL
8	63.22.010	Kanal Geçiş Kapağı	1 10,50 TL
9	63.22.015	Sayaç Kapama	9 25,45 TL
10	63.22.016	TE Kapama	20 21,50 TL
11	63.22.017	Açılı Dış Köşe	50 22,35 TL
	63.22.018	Açılı İç Köşe	50 22,70 TL

► Hortum Kanalları ve Ek Parçaları - DN 32

KOD	AÇIKLAMA	K. AD.	B. FİYATI
63.44.003	L Köşe DN 32	-	21,00 TL
63.44.004	Dış Köşe DN 32	-	16,68 TL
63.44.005	İç Köşe DN 32	-	16,45 TL
63.44.006	Duvar Geçiş Kapağı (Kapalı)	-	25,20 TL
63.44.007	Duvar Geçiş Kapağı (Açık)	-	23,61 TL
63.44.001	Hortum Kanalı 3 mt DN 32	-	253,40 TL
63.44.010	Kanal Geçiş Kapağı	-	13,42 TL



► Sayaç Bağlantı Rakorları (Test Purjölü)

KOD	AÇIKLAMA	K. AD.	B. FİYATI
1	60.20.125	DN 20 - 3/4"	16 355,00 TL
2	60.25.117-2	DN 25 - 1" Dış Dişli Selenoid Bağlantılı	16 231,00 TL
3	60.25.118-2	DN 25 - 1" İç Dişli	16 195,00 TL
4	60.25.125-2	DN 25 - 1 1/4" Döküm Rakorlu	25 335,00 TL
5	60.25.126-2	DN 25 - 1 1/4" Rakorlu	25 290,00 TL
6	60.32.126	DN 32 - 1 1/4" Test Purjölü	20 991,00 TL



► Bağlantı Kelepçeleri

KOD	AÇIKLAMA	K. AD.	B. FİYATI
1	60.04.011	1/2" Vana Bağlantı	300 15,46 TL
	60.04.012	3/4" Vana Bağlantı	300 13,20 TL
2	60.04.020	DN 20 Te Bağlantı	200 8,67 TL
	60.04.025	DN 25 Te Bağlantı	200 14,68 TL
	60.04.032	DN 32 Te Bağlantı	150 10,60 TL
3	60.05.020	DN 20 Hortum Bağlantı	100 0,00 TL
	60.05.025	DN 25 Hortum Bağlantı	100 0,00 TL

▶ ARMATÜR



Kalitede Standartları Aştık!

KAS kalitesinde üretilen banyo, duş, lavabo ve mutfaklarda kullanılan armatürler su ve enerji tasarrufu sağlayarak, ev ekonomisine katkıda bulunuyor



KAS

Eniğin her yerindedir!

Yasemin Gold



► Yasemin Gold



► **Banyo Bataryası**
92.41.911

K. AD.: 10
2.306,00 TL



► **Lavabo Bataryası**
92.41.912

K. AD.: 6
1.984,00 TL



► **Evye Bataryası**
92.41.914

K. AD.: 6
2.892,00 TL



KAS

Eniçgu her yarındağz!

Yasemin



► Yasemin



► Banyo Bataryası

92.41.811

K. AD.: 10

1.596,00 TL



► Lavabo Bataryası

92.41.812

K. AD.: 6

1.425,00 TL



► Evye Bataryası

92.41.814

K. AD.: 6

2.300,00 TL



KAS

Sanayinin her yanındayız!

Lilyum



► Lilyum



► Banyo Bataryası

92.43.001

K. AD.: 12

1.109,00 TL



► Lavabo Bataryası

92.43.002

K. AD.: 12

987,00 TL



► Lüks Evye Bataryası

92.43.004

K. AD.: 12

1.394,00 TL



► Evye Bataryası

92.43.005

K. AD.: 12

749,00 TL



KAS

Eniçge her yerindeyiz!

Arnika



► Arnika



► **Banyo Bataryası**
92.42.101
 K. AD.: 12
940,00 TL



► **Lavabo Bataryası**
92.42.102
 K. AD.: 12
794,00 TL



► **Duř Bataryası**
92.42.108
 K. AD.: 12
660,00 TL



► **Aplike Evye Bataryası**
92.42.107
 K. AD.: 12
699,00 TL



► Arnika



► Lavabo Bataryası

K. AD.: 12

► **U** 92.42.117
728,00 TL

► **L** 92.42.119
745,00 TL



► Evye Bataryası

K. AD.: 12

► **U** 92.42.118
767,00 TL

► **L** 92.42.120
760,00 TL

► Gülbahar



► Tek Girişli Lavabo Bataryası

92.55.057

K. AD.: 12
352,00 TL



KAS
Esniğin her yerindediz!



Tüm Armatür Ürünlerimiz
320 Farklı Renk
Seçeneđi ile
Zevkinize Göre Sizlerle...

KAS

Herçekten her şeyden iyidir!

Defne

colored



► Defne Colored



► **Banyo Bataryası**
92.42.801-B2

K. AD.: 12
1.197,00 TL



► **Lavabo Bataryası**
92.42.802-B4

K. AD.: 12
1.111,00 TL



► **Evye Bataryası**
92.42.806-B3

K. AD.: 12
1.608,00 TL



► **Evye Bataryası**
92.42.807-B1

K. AD.: 12
918,00 TL



KAS

Sanayi her yerindedir!

Defne



► Defne



► **Banyo Bataryası**
92.42.801

K. AD.: 12

1.080,00 TL



► **Lavabo Bataryası**
92.42.802

K. AD.: 12

1.010,00 TL



► **Evye Bataryası**
92.42.806

K. AD.: 12

1.499,00 TL



► **Lavabo Bataryası**
92.42.809

K. AD.: 12

751,00 TL



► **Evye Bataryası**
92.42.807

K. AD.: 12

794,00 TL



KAS

Kaınıqın her yerindeyiz!

Hilal



▶ **Banyo Bataryası****92.31.201**

K. AD.: 12

981,00 TL▶ **Lavabo Bataryası****92.31.202**

K. AD.: 12

899,00 TL

► **Hilal**



► **Lavabo Bataryası**
K. AD.: 12

► **U** 92.31.215
849,00 TL

► **L** 92.31.205
862,00 TL



► **Evye Bataryası**
K. AD.: 12

► **U** 92.31.216
895,00 TL

► **L** 92.31.206
902,00 TL



KAS®

Evimizin her yerindeyiz!

Antoryum Banyo Bataryası

Antoryum serisi banyo bataryası, muadil ürünlere göre daha uzun gaga boyuna ve daha büyük bir gövde yapısına sahiptir. Buna rağmen Antoryum banyo bataryası, muadil ürünlerle karşılaştırıldığında daha hafif bir ağırlığa sahiptir. Tasarımı ve mühendislik süreçleri optimum görünümü ve ağırlığı sağlamak amacıyla planlanmıştır.



**153mm
Gövde Yapısı**



Bice Yok

! Kol üzerindeki bağlantı deliğini kapatan bice mevcut kollarda ön tarafta bulunduğu için zamanla kireç tutmaya başlar, Antoryum serisi kollarda bağlantı deliğinin arkada bulunmasından ötürü böyle bir görünüme neden olmaz.

Huni Yok

! Sıkma somunu üzerine gelen huninin zamanla kolun açılıp kapanmasıyla üzerinde oluşan deformasyondan ötürü kireç birikimi meydana gelmektedir. Antoryum da huni olmadığı için böyle bir deformasyon oluşmamaktadır.



Hibrit Yönlendirici

Normal yönlendiriciler açıldıkları zaman tekrar kullanıcı tarafından kapatılmalı ve kontrol edilmelidir. Aksi halde armatür açıldığı zaman yönlendirici yukarıda kalmış ise kullanıcı soğuk suya maruz kalır, Antoryum serisinde bulunan hibrit yönlendirici ise armatür kapatıldığı zaman otomatik olarak kendini kapatmaktadır. Böylece daha sonra armatür açıldığı zaman kontrollü ve kaliteli bir kullanım sağlar.



KAS

Sanayi her yerindedir!

Antoryum



► Antoryum



► **Banyo Bataryası**

92.31.951

K. AD.: 12

826,00 TL



► **Lavabo Bataryası**

92.31.952

K. AD.: 12

981,00 TL



► Antoryum



► **Lavabo Bataryası**
92.31.953
K. AD.: 12
577,00 TL



► **Evye Bataryası**
92.31.954
K. AD.: 12
590,00 TL



► **Aplike Evye Bataryası**
92.31.957
K. AD.: 12
795,00 TL



► **Duş Bataryası**
92.31.958
K. AD.: 12
732,00 TL



KAS®

Evinizin her yerindeyiz!

Yeni Nesil Fotoselli Armatürler

Kas sistem fotoselli armatürler, **teknolojik ve inovatif** yaklaşımlarıyla dikkat çekiyor.

Kalite ve sağlamlık açısından oldukça güvenilirdir.

Oval Sensör Teknolojisi

Oval sensör teknolojisi sayesinde perlatör üstüne yerleştirilen sensör kamufile edilerek daha sade bir görünüm sağlamaktadır.

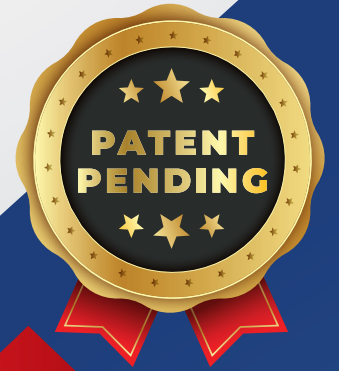

KAS

Her zaman her yerindeyiz!

Gülnihal



► Gülnihal



► **Banyo Bataryası**
92.42.201
 K. AD.: 12
890,00 TL



► **Lavabo Bataryası**
92.42.202
 K. AD.: 12
765,00 TL



► **Aplike Evye Bataryası**
92.42.207
 K. AD.: 12
722,00 TL



► **Duř Bataryası**
92.42.208
 K. AD.: 12
652,00 TL



► **Gülnehal**



► **Lavabo Bataryası**

K. AD.: 12

► **U** 92.42.215
601,00 TL

► **L** 92.42.220
610,00 TL



► **Evye Bataryası**

K. AD.: 12

► **U** 92.42.216
620,00 TL

► **L** 92.42.221
632,00 TL



► Gülnihal



► Lavabo Bataryası

K. AD.: 12

► **F** 92.42.203
670,00 TL

► **L** 92.42.205
576,00 TL



► Evye Bataryası

K. AD.: 12

► **F** 92.42.204
701,00 TL

► **L** 92.42.206
610,00 TL



KAS

her zaman her yerinizde!

Çanak

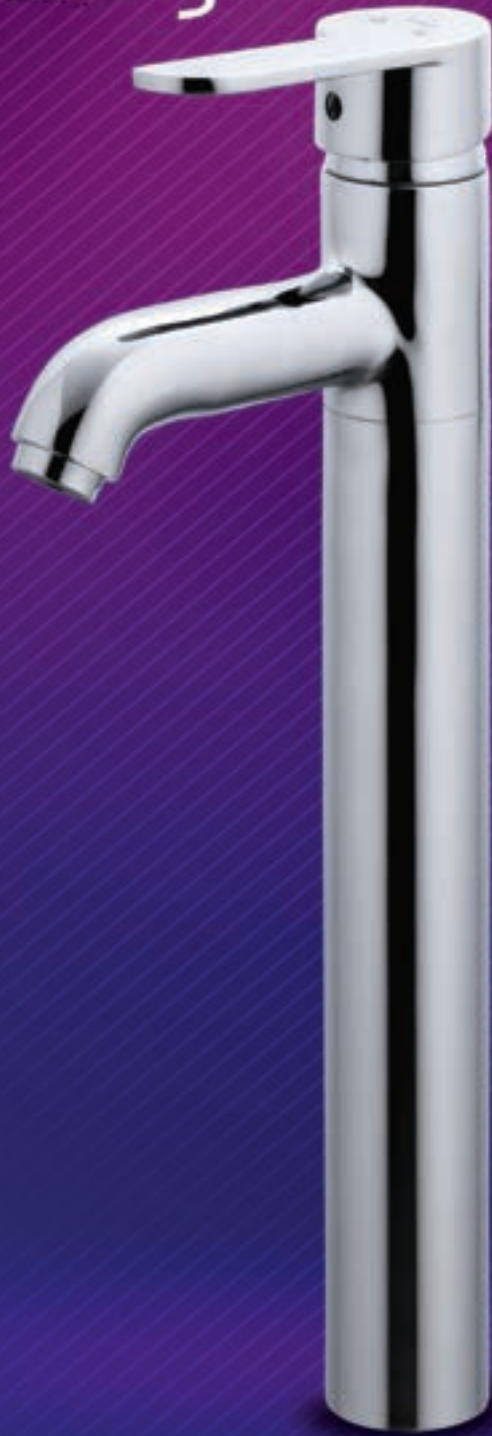

► Çanak



► **Gülnehal Çanak Lavabo**
92.42.217
 K. AD.: 6
1.954,00 TL



► **Gülbade Çanak Lavabo**
92.41.255
 K. AD.: 6
3.558,00 TL



► **Manolya Çanak Lavabo**
92.41.617
 K. AD.: 6
2.011,00 TL



KAS

Eniçun her yarındıyız!

Kardelen



► Kardelen



► **Banyo Bataryası**
92.31.701
 K. AD.: 12
805,00 TL



► **Lavabo Bataryası**
92.31.702
 K. AD.: 12
744,00 TL



► **Lavabo Bataryası**
92.31.703
 K. AD.: 12
494,00 TL



► **Evye Bataryası**
92.31.704
 K. AD.: 12
519,00 TL



KAS

her zaman her yerinizdeyiz!

Nilüfer



► Nilüfer



► **Banyo Bataryası**
92.41.301
 K. AD.: 12
753,00 TL



► **Lavabo Bataryası**
92.41.302
 K. AD.: 12
662,00 TL



► **Lavabo Bataryası**
92.41.303
 K. AD.: 12
471,00 TL



► **Evye Bataryası**
92.41.304
 K. AD.: 12
481,00 TL



KAS

En uygun her yerindeyiz!

Zirkonyum



► Zirkonyum



► Banyo Bataryası 92.31.901

K. AD.: 12
692,00 TL



► Lavabo Bataryası 92.31.902

K. AD.: 12
623,00 TL



► Zirkonyum



► **Lavabo Bataryası**
92.31.903
K. AD.: 12
441,00 TL



► **Evye Bataryası**
92.31.904
K. AD.: 12
453,00 TL



► **Aplike Evye Bataryası**
92.31.932
K. AD.: 12
783,00 TL

► Zirkonyum



► **Yarı Ankastre
Banyo Bataryası**
92.31.920
K. AD.: 12
993,00 TL



► **Aplike Evye Bataryası**
92.31.907
K. AD.: 12
731,00 TL



► **Duş Bataryası**
92.31.908
K. AD.: 12
693,00 TL



► **Döner Lavabo Bataryası**
92.31.930
K. AD.: 12
592,00 TL



► **Döner Evye Bataryası**
92.31.931
K. AD.: 12
603,00 TL



► Zirkonyum Medikal



► **Aplike Evye Bataryası**
92.31.913
K. AD.: 12
713,00 TL



► **Lavabo Bataryası**
92.31.912
K. AD.: 12
617,00 TL



► **Döner Lavabo Bataryası**
92.31.910
K. AD.: 12
588,00 TL



► **Döner Evye Bataryası**
92.31.911
K. AD.: 12
601,00 TL

KAS®

Esinizin her yerindeyiz!

Kuğu Lavabo & Evye Bataryaları



KAS sistem kuğu lavabo ve evye bataryaları özel olarak tasarlanıp üretilen su akış sistemi sayesinde, insan sağlığına zararlı kanserojen madde sınıfında bulunan pirinç içerisindeki kurşunu barındıran yüzeye temas etmeden kullanıcıya iletilmesini sağlamaktadır.



Tamamen Kurşuna Maruz Kalmamış Su Kullanımı

Uzun ömürlü malzeme kullanımı ürünün kullanım süresini arttırmaktadır. Özel tasarlanmış parçalar sayesinde ürün kompakt bir yapıya sahiptir. Bu özelliği ürünün kolay montaj yapılmasını ve kullanıcının sağlıklı bir şekilde su ihtiyacını karşılamasını sağlamaktadır.



KAS

Enigma her yerindeyiz!

Berilyum



► Berilyum



► Banyo Bataryası

92.42.901

K. AD.: 12

668,00 TL



► Lavabo Bataryası

92.42.902

K. AD.: 12

575,00 TL



► Lavabo Bataryası

92.42.903

K. AD.: 12

432,00 TL



► Evye Bataryası

92.42.904

K. AD.: 12

452,00 TL



► Berilyum



► **Yarı Ankastr**
Banyo Bataryası
92.42.910
K. AD.: 12
999,00 TL



► **Aplike Evye Bataryası**
92.42.907
K. AD.: 12
651,00 TL



► **Duř Bataryası**
92.42.908
K. AD.: 12
612,00 TL



► **Döner Lavabo Bataryası**
92.42.915
K. AD.: 12
584,00 TL



► **Döner Evye Bataryası**
92.42.916
K. AD.: 12
596,00 TL



KAS®

Evimizin her yerindeyiz!

Yeni Nesil Aç-Kapa Taharet

Özenli, özverili teknik çalışmalar ve ince detaylarla **KAS** aç-kapa taharet ürünü düşük çevirme sayesinde ergonomi ve tasarruf sağlar.

Özel Conta Kullanımı

KAS Sistem

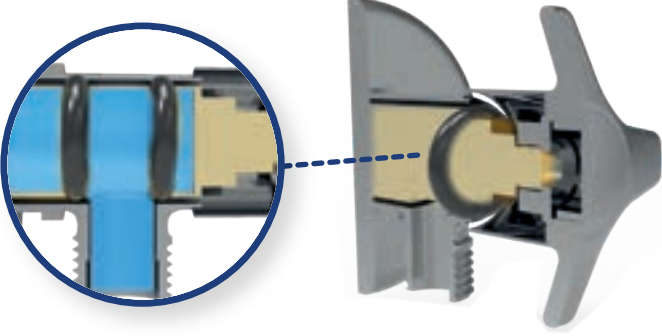

Yeni geliştirdiğimiz sistemde özel üretilen conta sayesinde tesisattan gelen pisliğin meydana getirdiği zarar %90 oranında ortadan kalkmaktadır.

Diğer Ürünler

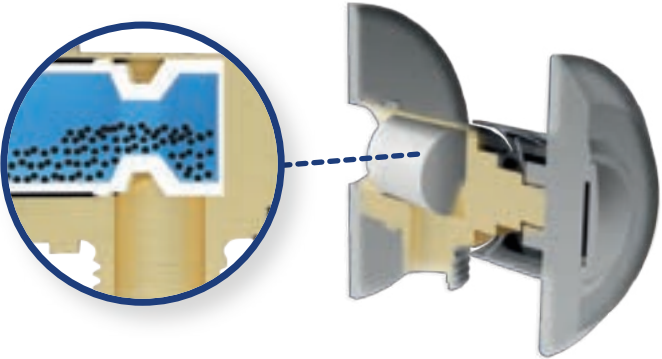

Tesisata doğru gelen pislik piyasa ürünlerinde kullanılan seramiği çizdiğinden dolayı çok kısa sürede sızdırmaya ve tesisatın bozulmasına sebep olmaktadır.



200° Kontrol Aralığı

KAS Sistem



Aç - Kapa ürünümüz 200° kullanım aralığı sağladığı için daha kontrollü ve konforlu su akışı sağlamaktadır. Bu özelliğiyle etrafa su sıçrama problemini ortadan kaldırmaktadır.

Diğer Ürünler



Diğer ürünlerde Aç - Kapa kullanım aralığı 70°dir. Düşük kullanım aralığından dolayı kontrolsüz ve konforsuz bir kullanım söz konusudur. Bu nedenle kullanım esnasında etrafa su sıçraması yüksek olasılıktır.

KAS®

Evimizin her yerindeyiz!

%50

'ye Varan Tasarruf sağlamaktadır.

**Sistem
Aç - Kapa
Taharete**

KAS

En uygun her geridekiyi

Mutfak Ürünleri



► Mutfak Ürünleri



► **Evye Bataryası (Aırtmal)**
92.42.222
 K. AD.: 12
1.887,00 TL



► **Evye Bataryası (Aırtmal)**
92.42.223
 K. AD.: 12
1.874,00 TL



► **Gülnihal Evye Bataryası (Aırtmal)**
92.42.226
 K. AD.: 12
1.699,00 TL



► **Spiralli Evye Bataryası**
92.31.220
 K. AD.: 12
1.860,00 TL



► Mutfak Ürünleri



► **Spiralli Evye Bataryası**
92.52.003

K. AD.: 12
1.974,00 TL



► **Spiralli Evye Bataryası**
92.31.221

K. AD.: 12
1.861,00 TL



► Mutfak Ürünleri



► Akrobat Evye Bataryası 92.31.041

K. AD.: 12
1.718,00 TL



► Akrobat Evye Bataryası 92.31.042

K. AD.: 12
1.748,00 TL



► Endüstriyel Mutfak Ürünleri



► **Endüstriyel
Çift Çıkışlı Evye Bataryası**
92.52.001

K. AD.: 12

3.417,00 TL



► **Endüstriyel
Tek Çıkışlı Evye Bataryası**
92.52.002

K. AD.: 12

2.166,00 TL

KAS®

Esniğiniz her yerindeyiz!

Triptonik Sensörlü Su Armatürü



- Ürün içerisinde dereceli dönen kartuş sistemi mevcuttur.
- Ürün mekanik tasarımı sayesinde hem sensör hem de manuel aç-kapa kolu ile elektrik kesintisinde bile kullanıcıya su akışı sağlamaktadır.
- Avrupa üretimi sensör teknolojisi.
- Pili ürünler her ne kadar elektrikli ürünlere göre problemsiz gözükseler bile ortalama 6 ay da bir pil değişimine ihtiyaç duyarlar ve triptonik aç-kapa bataryanın kullanım konforuna ulaşamazlar.



Zarif ve İnce Tasarım
%100 Piringç Ürün



Elektrik devre dışı kaldığı zamanlarda ise manuel aç-kapa sistemi sayesinde su akışı sağlanabilmektedir.



Elektrik devredeyken ürünler sensör kullanımına olanak sağlamaktadır.



KAS

Environnement et économie

Fotoselli



► Fotoselli



► Sardunya Fotoselli Lavabo Bataryası 92.51.031 - Çift Çıkışlı

K. AD.: 12
3.332,00 TL

92.51.041 - Tek Çıkışlı

K. AD.: 12
2.854,00 TL



► Petunya Fotoselli Lavabo Bataryası 92.51.011 - Çift Çıkışlı

K. AD.: 12
3.128,00 TL

92.51.021 - Tek Çıkışlı

K. AD.: 12
2.650,00 TL



► Fulya Fotoselli Lavabo Bataryası 92.51.051 - Çift Çıkışlı

K. AD.: 12
3.140,00 TL

92.51.061 - Tek Çıkışlı

K. AD.: 12
2.662,00 TL



Renk seçenekleri için fiyat sorunuz.



► Fotoselli



► **Antoryum Fotoselli
Lavabo Bataryası**
92.51.069 - Çift Çıkışlı - "U"

K. AD.: 12
2.791,00 TL

92.51.068 - Tek Çıkışlı - "U"

K. AD.: 12
2.407,00 TL



► **Antoryum Fotoselli
Lavabo Bataryası**
92.51.072 - Çift Çıkışlı - "L"

K. AD.: 12
2.785,00 TL

92.51.071 - Tek Çıkışlı - "L"

K. AD.: 12
2.400,00 TL



► **Gülsude Fotoselli
Lavabo Bataryası**
92.51.074 - Çift Çıkışlı

K. AD.: 12
2.904,00 TL

92.51.073 - Tek Çıkışlı

K. AD.: 12
2.519,00 TL



► Fotoselli Triptonik



► **Gülnür Fotoselli Triptonik
Lavabo Bataryası**
92.51.065 - Çift Çıkışlı

K. AD.: 12
3.291,00 TL

92.51.064 - Tek Çıkışlı
K. AD.: 12
2.906,00 TL



► **Lilyum Fotoselli Triptonik
Lavabo Bataryası**
92.51.063 - Çift Çıkışlı

K. AD.: 12
2.794,00 TL

92.51.062 - Tek Çıkışlı
K. AD.: 12
2.327,00 TL



► **Gülnür Çanak Fotoselli Triptonik
Lavabo Bataryası**
92.51.067 - Çift Çıkışlı

K. AD.: 12
3.515,00 TL

92.51.066 - Tek Çıkışlı
K. AD.: 12
3.131,00 TL



► Ankastre



► Zaman Ayarlı Pisuvar Musluğu

92.81.005

K. AD.: 8

591,00 TL



► Pisuvar Musluğu

92.81.004

K. AD.: 12

676,00 TL



► Aç-Kapa Ankastre

92.11.434 1/2"

K. AD.: 50

207,00 TL

92.11.435 3/4"

K. AD.: 50

207,00 TL



► Aç-Kapa Ankastre

92.11.432 1/2"

K. AD.: 50

207,00 TL

92.11.433 3/4"

K. AD.: 50

207,00 TL



► Aç-Kapa Ankastre

92.11.430 1/2"

K. AD.: 50

181,00 TL

92.11.431 3/4"

K. AD.: 50

181,00 TL



► Aç-Kapa Ankastre (Metal Volan)

92.11.436 1/2"

K. AD.: 50

229,00 TL

92.11.437 3/4"

K. AD.: 50

229,00 TL

► Musluk



► **Kumru Aç - Kapa
Kısa Musluk**
92.11.201
K. AD.: 50
317,00 TL



► **Kumru Aç - Kapa
Uzun Musluk**
92.11.202
K. AD.: 50
320,00 TL



► **Kumru Aç - Kapa
Çamaşır Musluk**
92.11.203
K. AD.: 30
317,00 TL



► **Nehir Aç - Kapa
Kısa Musluk**
92.11.016
K. AD.: 50
174,00 TL



► **Nehir Aç - Kapa
Uzun Musluk**
92.11.017
K. AD.: 50
174,00 TL



► **Nehir Aç - Kapa
Çamaşır Musluk**
92.11.019
K. AD.: 30
174,00 TL

► Musluk



► **Topaç Kısa Musluk**
92.11.001

K. AD.: 50
152,00 TL



► **Topaç Uzun Musluk**
92.11.002

K. AD.: 50
152,00 TL



► **Topaç Çamaşır Musluk**
92.11.003

K. AD.: 50
152,00 TL



► **Piramit Uzun Musluk**
92.11.102

K. AD.: 50
155,00 TL



► **Piramit Çamaşır Musluk**
92.11.103

K. AD.: 50
155,00 TL



► **Piramit Kısa Musluk**
92.11.101

K. AD.: 50
155,00 TL

► Taharet Musluğu (Aç-Kapa)



► **Deniz**
92.11.365 3/8"
 K. AD.: 50
95,20 TL



► **Nehir**
92.11.366 3/8"
 K. AD.: 50
95,20 TL



► **Irmak**
92.11.367 3/8"
 K. AD.: 50
95,20 TL



► **Damla**
92.11.368 3/8"
 K. AD.: 50
116,00 TL



► **Yağmur**
92.11.332 3/8"
 K. AD.: 50
288,00 TL



► **Yaprak**
92.11.347 3/8"
 K. AD.: 50
198,00 TL



► Taharet Musluğu (Aç-Kapa)



► **Billur**
92.11.369 3/8"
K. AD.: 50
120,00 TL



► **Pınar**
92.11.370 3/8"
K. AD.: 50
125,00 TL



► **Sude**
92.11.373 3/8"
K. AD.: 50
93,40 TL



► **Çisil**
92.11.374 3/8"
K. AD.: 50
127,00 TL



► **Derya**
92.11.371 3/8"
K. AD.: 50
119,00 TL



► **Papatya**
92.11.375 3/8"
K. AD.: 50
99,70 TL

► Yedek Parça



► **Sude Volan**
91.10.128
K. AD.: 50
24,00 TL



► **Yonca Volan (Beyaz)**
91.10.129
K. AD.: 50
21,70 TL



► **Yıldız Volan (Kromlu)**
91.10.130
K. AD.: 50
22,40 TL



► **Yıldız Volan (Beyaz)**
91.10.127
K. AD.: 50
22,10 TL



► **Topaç Volan**
91.10.121
K. AD.: 50
49,69 TL



► **Topaç Volan ve Salmastra**
91.10.341
K. AD.: 50
76,80 TL



► **Piramit Volan**
91.10.122
K. AD.: 50
50,70 TL



► **Piramit Volan ve Salmastra**
91.10.342
K. AD.: 50
77,20 TL

► Yedek Parça



► Taharet Salmastrası

92.10.013

K. AD.: 50

44,76 TL



► 35'lik Kısa Kartuş

91.10.232

K. AD.: 50

48,10 TL



► Aç - Kapa Salmastra

91.10.012

K. AD.: 50

82,70 TL



► 35'lik Ayaklı Kartuş

91.10.231

K. AD.: 50

50,60 TL



► Salmastra

91.10.011

K. AD.: 50

50,10 TL



► 40'lik Kısa Kartuş

91.10.233

K. AD.: 50

48,10 TL



► 40'lik Ayaklı Kartuş

91.10.234

K. AD.: 50

46,12 TL

► Yedek Parça



► **Lavabo
Batarya Borusu "L"**
91.10.071

K. AD.: 50
65,80 TL



► **Lavabo
Batarya Borusu "U"**
91.10.073

K. AD.: 50
80,80 TL



► **Lavabo
Batarya Borusu "R"**
91.10.075

K. AD.: 50
60,20 TL



► **Evye
Batarya Borusu "L"**
91.10.072

K. AD.: 50
59,80 TL



► **Evye
Batarya Borusu "U"**
91.10.074

K. AD.: 50
75,20 TL



► **Evye
Batarya Borusu "R"**
91.10.076

K. AD.: 50
52,80 TL



► **Bağlantı Hortumu**
91.10.021

K. AD.: 50
41,10 TL



► **Tek Delikli
Bağlantı Parçaları**
91.10.035

K. AD.: 50
28,80 TL



► **Çift Delikli
Bağlantı Parçaları**
91.10.037

K. AD.: 50
31,90 TL



DUŞ SETLERİ



Modern, estetik ve fonksiyonel duř setlerimiz ile
banyonuza seękin bir hava
katıyoruz...

Klasik ya da modern her türlü banyoya kolaylıkla uyum sağlayabilen řıklıktaki duř setlerimiz dekorasyonunuzun tamamlayıcı parçası olacak.



► **Ankastre Batarya - Duş Seti**



► **Defne**
Gagadan Kontrollü
Ankastre Duş Seti
(Kare - İki Yollu)
92.82.802

K. AD.: 8
3.060,00 TL

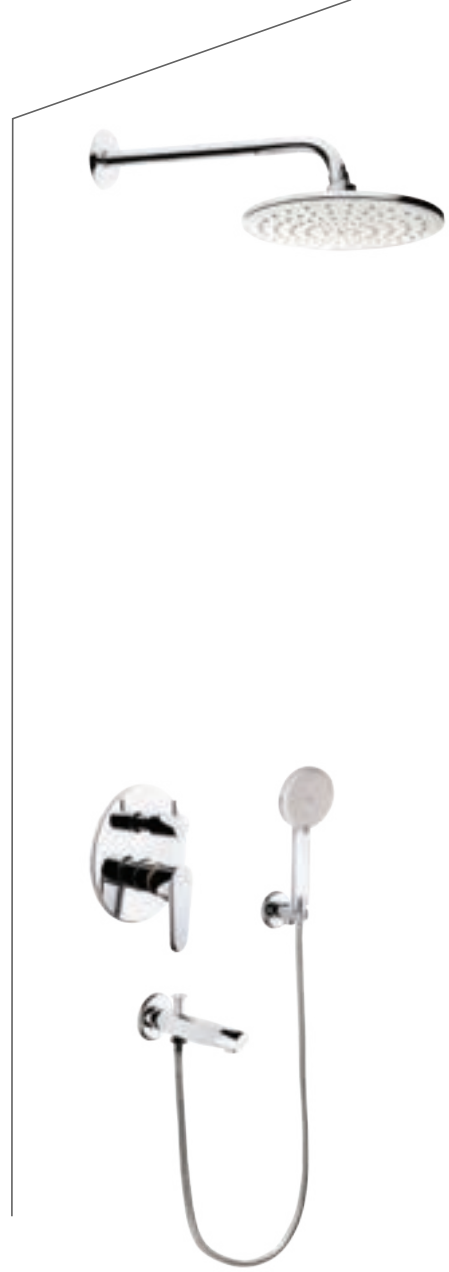

► **Arnika**
Gagadan Kontrollü
Ankastre Duş Seti
(Yuvarlak - İki Yollu)
92.82.102

K. AD.: 8
2.828,00 TL



► Ankastra Batarya - Duş Seti



► **Defne**
Kumanda Kontrollü
Ankastra Duş Seti
(Kare - Üç Yollu)
92.82.803

K. AD.: 8
3.246,00 TL

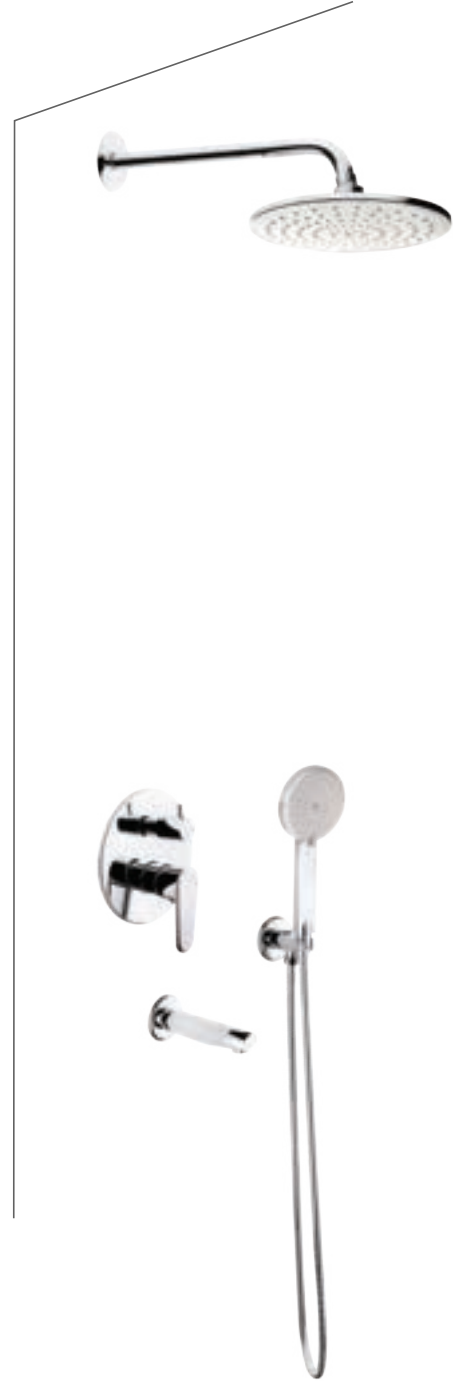

► **Arnika**
Kumanda Kontrollü
Ankastra Duş Seti
(Yuvarlak - Üç Yollu)
92.82.103

K. AD.: 8
3.014,00 TL



► **Ankastre Batarya - Duş Seti**



► **Defne**
Ankastre Duş Seti
(Kare - İki Yollu)
92.82.801

K. AD.: 8
2.858,00 TL



► **Arnika**
Ankastre Duş Seti
(Yuvarlak - İki Yollu)
92.82.101

K. AD.: 8
2.646,00 TL



► Panel Duş Seti



- **Inci**
91.30.510
K. AD.: 1
2.632,00 TL

► Tepe Duş Setleri



► Tepe Duş Setleri



► Tepe Duş Setleri



► **Elmas**
91.31.310
K. AD.: 4
767,00 TL

► Tepe Duş Setleri



► **Yakut**
91.31.210
 K. AD.: 4
698,00 TL



► Sürgülü Duş Setleri



- **Safir**
91.31.420
K. AD.: 12
301,00 TL

► Sürgülu Duş Setleri



► **Kuartz**
91.31.020
 K. AD.: 12
302,00 TL



► **Elmas**
91.31.320
 K. AD.: 12
198,00 TL



► Sürgülü Duş Setleri



► **Yakut**
91.31.220
K. AD.: 12
205,00 TL



► **Zümrüt**
91.31.120
K. AD.: 12
170,00 TL

► Mafsallı Duş Setleri



► **Safir**
91.31.430
 K. AD.: 28
219,00 TL



► **Kuartz**
91.31.030
 K. AD.: 28
218,00 TL

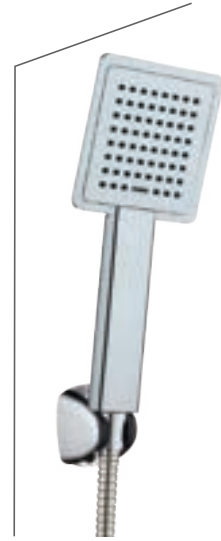

► **Elmas**
91.31.330
 K. AD.: 28
129,00 TL



► **Yakut**
91.31.230
 K. AD.: 28
139,00 TL



► **Zümrüt**
91.31.130
 K. AD.: 28
99,60 TL

► Mafsallı Duş Setleri



- **Çok Fonksiyonlu El Tipi
Duş Başlığı**
91.10.812
K. AD.: 12
136,00 TL



- **Duş Başlığı**
91.10.811
K. AD.: 18
154,00 TL



- **Kromlu Spiral Hortum - 011**
1/2" - 1/2" 150 - 180 cm
91.20.202
110,00 TL



- **Mat Spiral Hortum - 09**
1/2" - 1/2" 150 cm
91.20.200
57,10 TL

► Mafsallı Duş Setleri



► **Zümrüt Duş Seti**
91.31.131

K. AD.: 28
99,90 TL



► **Azurit Duş Seti**
91.31.531

K. AD.: 28
224,00 TL



► **Lagos Duş Seti**
91.31.631

K. AD.: 28
113,00 TL



► **Kuartz Duş Seti**
91.31.031

K. AD.: 28
217,00 TL

▶ PPRC GRUBU



Hem uygulayıcının, hem kullanıcının yanındayız.

Gönül rahatlığıyla için

KAS PPRC ürünlerinin kaygan ve parlak iç yüzeyleri sayesinde **suyun rengi ve tadı asla değişmiyor.** Folyosu ortada olduğu için kesme, tıraşlama ve **montaj süreleri maksimum düzeyde kısılıyor.**



► PPRC GRUPLARI



► Pe-Rt Boru

KOD	AÇIKLAMA	K. AD.	B. FİYATI
80.20.016	16 x 2	200	9,88 TL
80.21.016	16x2 Kılıflı ■	100	13,10 TL
80.22.016	16x2 Kılıflı ■	100	13,10 TL
80.10.016	16x2 Oksijen Bariyerli	160	11,24 TL
80.11.016	16x2 Oksijen Bar. Kılıflı ■	100	14,49 TL
80.12.016	16x2 Oksijen Bar. Kılıflı ■	100	14,49 TL



► PPRC Alüminyum Folyolu Boru (PN25)

KOD	AÇIKLAMA	K. AD.	B. FİYATI
94.11.020	20 mm	4 x 25	20,67 TL
94.11.025	25 mm	4 x 20	29,31 TL
94.11.032	32 mm	4 x 15	48,59 TL
94.11.040	40 mm	4 x 10	73,45 TL
94.11.050	50 mm	4 x 5	115,00 TL
94.11.063	63 mm	4 x 4	177,80 TL



► PPRC Boru (PN16)

KOD	AÇIKLAMA	K. AD.	B. FİYATI
94.02.020	20 mm	4 x 25	12,00 TL
94.02.025	25 mm	4 x 20	18,17 TL
94.02.032	32 mm	4 x 15	34,16 TL
94.02.040	40 mm	4 x 10	53,98 TL
94.02.050	50 mm	4 x 5	83,77 TL
94.02.063	63 mm	4 x 4	132,80 TL
94.02.075	75 mm	4 x 3	194,90 TL
94.02.090	90 mm	4 x 2	309,00 TL
94.02.110	100 mm	4 x 1	449,00 TL

► PPRC Boru (PN20)

KOD	AÇIKLAMA	K. AD.	B. FİYATI
94.03.020	20 mm	4 x 25	13,28 TL
94.03.025	25 mm	4 x 20	19,44 TL
94.03.032	32 mm	4 x 15	32,42 TL
94.03.040	40 mm	4 x 10	51,15 TL
94.03.050	50 mm	4 x 5	84,50 TL
94.03.063	63 mm	4 x 4	130,10 TL
94.03.075	75 mm	4 x 3	195,30 TL
94.03.090	90 mm	4 x 2	295,00 TL
94.03.110	110 mm	4 x 1	447,00 TL

► PPRC GRUPLARI



► PPRC Kompozit Boru (PN20)

KOD	AÇIKLAMA	K. AD.	B. FİYATI
94.06.020	20 mm	4 x 25	15,13 TL
94.06.025	25 mm	4 x 20	23,55 TL
94.06.032	32 mm	4 x 15	38,43 TL
94.06.040	40 mm	4 x 10	57,31 TL
94.06.050	50 mm	4 x 5	96,11 TL
94.06.063	63 mm	4 x 4	146,30 TL
94.06.075	75 mm	4 x 3	209,80 TL
94.06.090	90 mm	4 x 2	309,00 TL
94.06.110	110 mm	4 x 1	463,00 TL

► PPRC Kompozit Boru (PN25)

KOD	AÇIKLAMA	K. AD.	B. FİYATI
94.07.020	20 mm	4 x 25	17,91 TL
94.07.025	25 mm	4 x 20	26,84 TL
94.07.032	32 mm	4 x 15	47,17 TL
94.07.040	40 mm	4 x 10	72,49 TL
94.07.050	50 mm	4 x 5	114,50 TL
94.07.063	63 mm	4 x 4	177,40 TL
94.07.075	75 mm	4 x 3	260,40 TL
94.07.090	90 mm	4 x 2	360,00 TL
94.07.110	110 mm	4 x 1	562,00 TL



► Kuyruklu Dirsek 90°

KOD	AÇIKLAMA	K. AD.	B. FİYATI
94.13.220	20 mm	300	4,49 TL
94.13.225	25 mm	150	6,74 TL
94.13.232	32 mm	90	11,51 TL

► TE Parça

KOD	AÇIKLAMA	K. AD.	B. FİYATI
94.15.020	20 mm	240	2,85 TL
94.15.025	25 mm	150	3,61 TL
94.15.032	32 mm	75	7,40 TL
94.15.040	40 mm	50	12,73 TL
94.15.050	50 mm	30	25,00 TL
94.15.063	63 mm	16	45,41 TL
94.15.075	75 mm	10	72,22 TL
94.15.090	90 mm	5	126,60 TL
94.15.110	110 mm	2	217,60 TL

► PPRC GRUPLARI



► Inegal TE

KOD	AÇIKLAMA	K. AD.	B. FİYATI
94.16.001	25x20x20 mm	200	3,90 TL
94.16.002	25x20x25 mm	150	4,10 TL
94.16.003	32x20x20 mm	90	7,31 TL
94.16.004	32x20x32 mm	80	8,12 TL
94.16.005	32x25x20 mm	90	6,34 TL
94.16.006	32x25x25 mm	90	7,71 TL
94.16.007	32x25x32 mm	80	7,56 TL
94.16.008	40x20x40 mm	60	11,43 TL
94.16.009	40x25x40 mm	60	12,20 TL
94.16.010	40x32x40 mm	50	12,49 TL
94.16.011	50x20x50 mm	32	23,24 TL
94.16.012	50x25x50 mm	32	23,10 TL
94.16.013	50x32x50 mm	32	23,28 TL
94.16.014	50x40x50 mm	32	25,20 TL
94.16.015	63x20x63 mm	18	39,69 TL
94.16.016	63x25x63 mm	18	42,82 TL
94.16.017	63x32x63 mm	18	44,65 TL
94.16.018	63x40x63 mm	18	44,65 TL
94.16.019	63x50x63 mm	18	46,29 TL
94.16.020	75x20x75 mm	12	108,10 TL
94.16.021	75x25x75 mm	12	108,00 TL
94.16.022	75x32x75 mm	12	107,93 TL
94.16.023	75x40x75 mm	12	109,15 TL
94.16.024	75x50x75 mm	12	108,10 TL
94.16.025	75x63x75 mm	12	110,47 TL
94.16.026	90x20x90 mm	5	147,80 TL
94.16.027	90x25x90 mm	5	147,50 TL
94.16.028	90x32x90 mm	5	147,30 TL
94.16.029	90x40x90 mm	5	147,10 TL
94.16.030	90x50x90 mm	5	146,80 TL
94.16.031	90x63x90 mm	5	147,40 TL
94.16.032	90x75x90 mm	5	150,60 TL
94.16.033	110x20x110 mm	3	228,30 TL
94.16.034	110x25x110 mm	3	228,20 TL
94.16.035	110x32x110 mm	3	224,90 TL
94.16.036	110x40x110 mm	3	224,80 TL
94.16.037	110x50x110 mm	3	224,60 TL
94.16.038	110x63x110 mm	3	224,00 TL
94.16.039	110x75x110 mm	3	224,30 TL
94.16.040	110x90x110 mm	3	225,90 TL



► Redüksiyon

KOD	AÇIKLAMA	K. AD.	B. FİYATI
94.19.001	25x20 mm	600	1,50 TL
94.19.002	32x20 mm	300	1,89 TL
94.19.003	32x25 mm	300	2,26 TL
94.19.004	40x20 mm	250	4,32 TL
94.19.005	40x25 mm	200	4,31 TL
94.19.006	40x32 mm	160	4,81 TL
94.19.007	50x20 mm	140	12,10 TL
94.19.008	50x25 mm	140	12,47 TL
94.19.009	50x32 mm	125	13,10 TL
94.19.010	50x40 mm	100	13,31 TL
94.19.011	63x20 mm	80	13,31 TL
94.19.012	63x25 mm	80	15,65 TL
94.19.013	63x32 mm	64	15,17 TL
94.19.014	63x40 mm	64	15,46 TL
94.19.015	63x50 mm	52	18,90 TL
94.19.016	75x50 mm	30	29,37 TL
94.19.017	75x63 mm	30	32,05 TL
94.19.018	90x40 mm	20	32,94 TL
94.19.019	90x50 mm	20	34,28 TL
94.19.020	90x63 mm	20	39,32 TL
94.19.021	90x75 mm	20	41,40 TL
94.19.022	110x50 mm	20	44,99 TL
94.19.023	110x63 mm	16	71,87 TL
94.19.024	110x75 mm	16	76,27 TL
94.19.025	110x90 mm	12	82,95 TL

► PPRC GRUPLARI



► Dirsek 45°

KOD	AÇIKLAMA	K. AD.	B. FİYATI
94.14.020	20 mm	400	2,23 TL
94.14.025	25 mm	300	3,05 TL
94.14.032	32 mm	150	4,99 TL
94.14.040	40 mm	80	8,76 TL
94.14.050	50 mm	48	17,00 TL
94.14.063	63 mm	21	28,37 TL
94.14.075	75 mm	12	68,66 TL
94.14.090	90 mm	10	109,60 TL
94.14.110	110 mm	4	150,40 TL



► Dirsek 90°

KOD	AÇIKLAMA	K. AD.	B. FİYATI
94.13.020	20 mm	400	1,69 TL
94.13.025	25 mm	200	2,62 TL
94.13.032	32 mm	125	4,95 TL
94.13.040	40 mm	60	9,83 TL
94.13.050	50 mm	30	17,59 TL
94.13.063	63 mm	18	32,16 TL
94.13.075	75 mm	12	49,30 TL
94.13.090	90 mm	6	92,95 TL
94.13.110	110 mm	3	150,70 TL



► Kapama Başlığı

KOD	AÇIKLAMA	K. AD.	B. FİYATI
94.18.020	20 mm	800	1,20 TL
94.18.025	25 mm	500	1,59 TL
94.18.032	32 mm	300	2,78 TL
94.18.040	40 mm	200	4,68 TL
94.18.050	50 mm	100	22,61 TL
94.18.063	63 mm	60	26,32 TL
94.18.075	75 mm	40	30,25 TL
94.18.090	90 mm	24	38,55 TL
94.18.110	110 mm	12	78,10 TL



► Manşon

KOD	AÇIKLAMA	K. AD.	B. FİYATI
94.17.020	20 mm	600	1,17 TL
94.17.025	25 mm	300	1,66 TL
94.17.032	32 mm	200	2,92 TL
94.17.040	40 mm	100	6,23 TL
94.17.050	50 mm	80	12,16 TL
94.17.063	63 mm	36	19,50 TL
94.17.075	75 mm	24	31,49 TL
94.17.090	90 mm	12	52,28 TL
94.17.110	110 mm	4	86,97 TL

► PPRC GRUPLARI



► C Kavis

KOD	AÇIKLAMA	K. AD.	B. FİYATI
94.12.220	20 mm	120	4,73 TL
94.12.225	25 mm	120	5,39 TL
94.12.232	32 mm	60	12,21 TL



► Manşonlu Kavis

KOD	AÇIKLAMA	K. AD.	B. FİYATI
94.12.120	20 mm	60	11,21 TL
94.12.125	25 mm	60	15,17 TL
94.12.132	32 mm	40	29,63 TL



► Kavis

KOD	AÇIKLAMA	K. AD.	B. FİYATI
94.12.020	20 mm	75	9,69 TL
94.12.025	25 mm	60	12,88 TL
94.12.032	32 mm	40	20,16 TL
94.12.040	40 mm	20	31,32 TL



► Kör Tapa

KOD	AÇIKLAMA	K. AD.	B. FİYATI
94.21.001	20 mm	900	1,21 TL
94.21.002	25 mm	600	1,36 TL
94.21.003	32 mm	400	2,34 TL
94.21.011	20 mm (Uzun)	900	2,36 TL
94.21.021	20 mm	200	2,77 TL

► PPRC GRUPLARI



► İstavroz

KOD	AÇIKLAMA	K. AD.	B. FİYATI
94.31.020	20 mm	200	9,85 TL
94.31.025	25 mm	140	10,84 TL
94.31.032	32 mm	60	13,14 TL
94.31.040	40 mm	40	17,53 TL



► Çekvalf

KOD	AÇIKLAMA	K. AD.	B. FİYATI
94.33.695	20 mm	100	36,66 TL
94.33.696	25 mm	50	43,31 TL



► PPRC Düz Radyatör Vanası

KOD	AÇIKLAMA	K. AD.	B. FİYATI
94.33.700	20 mm	100	70,90 TL
94.33.701	25 mm	60	79,47 TL



► PPRC Köşe Radyatör Vanası

KOD	AÇIKLAMA	K. AD.	B. FİYATI
94.33.702	20 mm	100	71,35 TL
94.33.703	25 mm	60	80,20 TL

► PPRC GRUPLARI

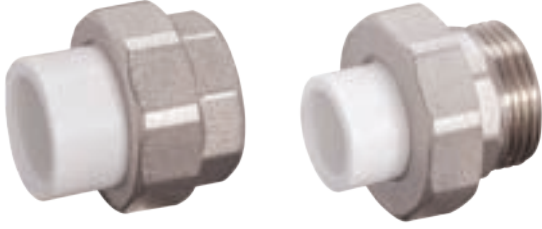

► Oynar Başlıklı Rakorlar - Kromlu

KOD	AÇIKLAMA	K. AD.	B. FİYATI
80.21.740	20x3/4" İç Dişli Rakor	200	32,04 TL
80.21.741	20x1" İç Dişli Rakor	200	57,40 TL
80.21.742	25x1/2" İç Dişli Rakor	200	51,51 TL
80.21.743	25x1" İç Dişli Rakor	150	53,75 TL
80.21.745	32x3/4" İç Dişli Rakor	100	60,83 TL
80.21.760	20x3/4" Dış Dişli Rakor	150	39,16 TL
80.21.761	20x1" Dış Dişli Rakor	200	68,25 TL
80.21.762	25x1/2" Dış Dişli Rakor	200	51,51 TL
80.21.763	25x1" Dış Dişli Rakor	100	60,94 TL
80.21.764	32x1/2" Dış Dişli Rakor	100	50,06 TL
80.21.765	32x3/2" Dış Dişli Rakor	80	66,52 TL



► Oynar Başlıklı Rakorlar - Kromlu

KOD	AÇIKLAMA	K. AD.	B. FİYATI
80.21.730	1/2" İç Dişli Rakor	200	31,97 TL
80.21.731	3/4" İç Dişli Rakor	150	49,53 TL
80.21.732	1" İç Dişli Rakor	100	58,96 TL
80.21.733	1 1/4" İç Dişli Rakor	50	96,75 TL
80.21.734	1 1/2" İç Dişli Rakor	30	156,70 TL
80.21.735	2" İç Dişli Rakor	20	296,10 TL
80.21.736	2 1/2" İç Dişli Rakor	20	534,00 TL
80.21.750	1/2" Dış Dişli Rakor	200	35,86 TL
80.21.751	3/4" Dış Dişli Rakor	150	55,00 TL
80.21.752	1" Dış Dişli Rakor	100	65,90 TL
80.21.753	1 1/4" Dış Dişli Rakor	50	116,40 TL
80.21.754	1 1/2" Dış Dişli Rakor	30	183,80 TL
80.21.755	2" Dış Dişli Rakor	20	345,00 TL



► Dış Dişli Nipel

KOD	AÇIKLAMA	K. AD.	B. FİYATI
94.23.001	20 mm x 1/2"	250	19,17 TL
94.23.002	20 mm x 3/4"	160	25,41 TL
94.23.003	25 mm x 1/2"	160	20,65 TL
94.23.004	25 mm x 3/4"	160	23,50 TL
94.23.005	32 mm x 1/2"	100	23,31 TL
94.23.006	32 mm x 3/4"	100	26,00 TL
94.23.007	32 mm x 1"	100	34,89 TL
94.23.008	40 mm x 1 1/4"	48	96,90 TL
94.23.009	50 mm x 1 1/2"	42	141,70 TL
94.23.010	63 mm x 2"	24	182,70 TL
94.23.011	75 mm x 2 1/2"	8	431,00 TL
94.23.012	90 mm x 3"	6	639,00 TL
94.23.013	110 mm x 3"	3	1.024,00 TL



► İç Dişli Nipel

KOD	AÇIKLAMA	K. AD.	B. FİYATI
94.22.001	20 mm x 1/2"	300	14,98 TL
94.22.002	20 mm x 3/4"	160	21,84 TL
94.22.003	25 mm x 1/2"	160	16,60 TL
94.22.004	25 mm x 3/4"	160	21,38 TL
94.22.005	32 mm x 1/2"	100	19,28 TL
94.22.006	32 mm x 3/4"	100	23,91 TL
94.22.007	32 mm x 1"	100	32,10 TL
94.22.008	40 mm x 1 1/4"	48	72,18 TL
94.22.009	50 mm x 1 1/2"	42	86,80 TL
94.22.010	63 mm x 2"	24	156,30 TL
94.22.011	75 mm x 2 1/2"	8	399,00 TL
94.22.012	90 mm x 3"	6	613,00 TL
94.22.013	110 mm x 4"	4	837,00 TL

► PPRC GRUPLARI



► Dış Dişli Dirsek

KOD	AÇIKLAMA	K. AD.	B. FİYATI
94.25.001	20 mm x 1/2"	160	21,00 TL
94.25.002	20 mm x 3/4"	120	27,26 TL
94.25.003	25 mm x 1/2"	120	21,26 TL
94.25.004	25 mm x 3/4"	120	25,62 TL
94.25.005	32 mm x 1/2"	60	29,55 TL
94.25.006	32 mm x 3/4"	60	32,63 TL
94.25.007	32 mm x 1"	60	46,82 TL



► İç Dişli Dirsek

KOD	AÇIKLAMA	K. AD.	B. FİYATI
94.24.001	20 mm x 1/2"	240	16,32 TL
94.24.002	20 mm x 3/4"	200	23,40 TL
94.24.003	25 mm x 1/2"	120	17,10 TL
94.24.004	25 mm x 3/4"	120	23,42 TL
94.24.005	32 mm x 1/2"	60	25,35 TL
94.24.006	32 mm x 3/4"	60	30,32 TL
94.24.007	32 mm x 1"	60	39,51 TL



► Dış Dişli TE

KOD	AÇIKLAMA	K. AD.	B. FİYATI
94.27.001	20 mm x 1/2"	160	20,15 TL
94.27.002	20 mm x 3/4"	150	25,00 TL
94.27.003	25 mm x 1/2"	100	22,57 TL
94.27.004	25 mm x 3/4"	100	25,34 TL
94.27.005	32 mm x 1/2"	60	29,48 TL
94.27.006	32 mm x 3/4"	60	32,16 TL
94.27.007	32 mm x 1"	60	40,73 TL



► İç Dişli TE

KOD	AÇIKLAMA	K. AD.	B. FİYATI
94.26.001	20 mm x 1/2"	160	16,10 TL
94.26.002	20 mm x 3/4"	150	22,90 TL
94.26.003	25 mm x 1/2"	100	18,97 TL
94.26.004	25 mm x 3/4"	100	23,85 TL
94.26.005	32 mm x 1/2"	60	26,00 TL
94.26.006	32 mm x 3/4"	60	30,77 TL
94.26.007	32 mm x 1"	60	34,54 TL

► PPRC GRUPLARI



► Dış Dişli Batarya Altı

KOD	AÇIKLAMA	K. AD.	B. FİYATI
94.29.001	20 mm x 1/2"	150	21,91 TL
94.29.002	25 mm x 1/2"	120	23,26 TL
94.29.003	25 mm x 3/4"	60	26,10 TL



► İç Dişli Batarya Altı

KOD	AÇIKLAMA	K. AD.	B. FİYATI
94.28.001	20 mm x 1/2"	150	17,71 TL
94.28.002	25 mm x 1/2"	120	19,04 TL



► Oynar Başlıklı Rakor

KOD	AÇIKLAMA	K. AD.	B. FİYATI
94.30.001	20 mm x 1/2"	300	27,67 TL
94.30.002	25 mm x 3/4"	200	36,54 TL
94.30.005	25 mm x 1/2"	250	27,65 TL
94.30.007	32 mm x 1"	160	77,00 TL



► Oynar Başlıklı Rakor

KOD	AÇIKLAMA	K. AD.	B. FİYATI
94.30.003	20 mm x 1/2"	200	29,94 TL
94.30.004	25 mm x 3/4"	150	39,96 TL

► PPRC GRUPLARI



► Batarya Altı (Tek Hat)

KOD	AÇIKLAMA	K. AD.	B. FİYATI
94.28.006	20 mm x 1/2"	50	40,80 TL



► Batarya Altı (Çift Hat)

KOD	AÇIKLAMA	K. AD.	B. FİYATI
94.28.004	20 mm x 1/2"	50	42,59 TL
94.28.005	25 mm x 1/2"	40	51,45 TL



► Kombi Bağlantı Seti

KOD	AÇIKLAMA	K. AD.	B. FİYATI
94.37.440	8'li Düz Set	20	259,70 TL
94.37.441	8'li Köşe Set	20	262,10 TL
94.37.442	10'lu Düz Set	12	331,00 TL
94.37.443	10'lu Köşe Set	12	333,00 TL



► Stop Vana

KOD	AÇIKLAMA	K. AD.	B. FİYATI
94.33.676	20 mm x 1/2"	60	59,65 TL
94.33.677	25 mm x 3/4"	50	70,48 TL
94.33.678	32 mm x 1"	30	99,11 TL

► PPRC GRUPLARI



► Küresel Vana

KOD	AÇIKLAMA	K. AD.	B. FİYATI
94.33.670	1/2"	80	35,26 TL
94.33.671	3/4"	70	40,27 TL
94.33.672	1"	60	50,44 TL
94.33.673	1 1/4"	20	106,40 TL
94.33.674	1 1/2"	10	189,80 TL
94.33.675	2"	10	347,00 TL

► Pislik Tutucu

KOD	AÇIKLAMA	K. AD.	B. FİYATI
94.33.680	1/2"	100	32,40 TL
94.33.681	3/4"	80	44,27 TL
94.33.682	1"	35	77,87 TL



► Kelepçe

KOD	AÇIKLAMA	K. AD.	B. FİYATI
94.20.020	20 mm Tekli	900	0,97 TL
94.20.025	25 mm Tekli	900	1,15 TL
94.20.032	32 mm Tekli	400	1,91 TL
94.20.040	40 mm Tekli	200	3,96 TL
94.20.220	20 mm Çiftli	400	2,27 TL
94.20.225	25 mm Çiftli	300	2,49 TL
94.20.232	32 mm Çiftli	200	4,12 TL
94.20.120	20 mm Tekli Kilitli	600	1,26 TL
94.20.125	25 mm Tekli Kilitli	600	2,17 TL
94.20.132	32 mm Tekli Kilitli	300	2,99 TL



ONLINE MÜŞTERİ HİZMETLERİ

www.kas.com.tr

Online ileti, anlık takip, kolay kullanım, hızlı sonuç.

KAS

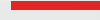

KAYALAR PRES, AEO sertifikasına sahip bir firmadır.

KASPA DIŞ TİC. A.Ş.

Necip Fazıl Mah. Sağdıç Sok. No: 4 Ümraniye / İSTANBUL - TURKEY
Tel: +90 216 527 1 527 Faks: +90 216 499 74 76 info@kas.com.tr

 / kas grup
www.kas.com.tr